

# RTX5032A

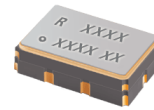

## SMD Temperature Compensated Crystal Oscillator

High performance TCXO offering excellent Phase Noise, Frequency Stability and VCO tilt compensation.



### Product description

The RTX5032A employs an analogue IC for the oscillator and temperature compensation. 5.0 mm x 3.2 mm in size.

### Applications

- Communications
- Basestation
- DSL/ADSL
- Femtocell
- Handset
- IP timing
- LTE
- Precision GPS
- SONET/SDH
- WiMAX/WiBro
- WLAN
- Other

### Features

- Excellent phase noise performance
- Excellent temperature stability
- Frequency slope and perturbation specifications can be customized to the application requirement
- Clipped sinewave or CMOS output options

### Specifications

#### 1.0 SPECIFICATION REFERENCES

Line	Parameter	Description
1.1	Model description	RTX5032A (Preliminary)
1.2	RoHS compliant	Yes
1.3	Filter	Enabled/Disabled
1.4	Reference number	
1.5	Rakon part number	

#### 2.0 FREQUENCY CHARACTERISTICS

Line	Parameter	Test Condition	Value	Unit
2.1	Frequency		5 to 52	MHz
2.2	Frequency calibration	Offset from nominal frequency measured at 25°C ± 2°C	±1 max	ppm
2.3	Reflow shift	Two consecutive reflows as per attached profile after 1 hour recovery at 25°C	±1 max	ppm
2.4	Frequency stability over temperature	Referenced to the midpoint between minimum and maximum frequency value over the specified temperature range (Note 1, 2)	±0.1 to 3	ppm
2.5	Temperature range	The operating temperature range over which the frequency stability is measured	-40 to 85	°C
2.6	Frequency slope	Minimum of 1 frequency reading every 2°C, over the operating temperature range (Note 1, 2)	0.1 max	ppm/°C
2.7	Static temperature hysteresis	Frequency change after reciprocal temperature ramped over the operating range. Frequency measured before and after at 25°C	0.4 max	ppm
2.8	Supply voltage stability	Supply voltage varied ±5% at 25°C	±0.1 max	ppm
2.9	Load sensitivity	±10% load change (Note 3)	±0.2 max	ppm
2.10	Long term stability	Frequency drift over 1 year at 25°C	±1 max	ppm

**3.0 POWER SUPPLY**

Line	Parameter	Test Condition	Value	Unit
3.1	Supply voltage	Nominal supply voltage range	2.8 to 5.5	V
3.2	Current	At maximum supply voltage (Note 3)	2.9 max	mA

**4.0 CONTROL VOLTAGE (VCO) OPTION**

Line	Parameter	Test Condition	Value	Unit
4.1	Control voltage range	The nominal control voltage value is midway between the minimum and maximum (Note 4)	0.5 to 4.5	V
4.2	Frequency tuning	Frequency shift from minimum to maximum control voltages	6 to 30	ppm
4.3	Port input impedance		100 min	k $\Omega$
4.4	Frequency tuning linearity	Deviation from straight line curve fit	10 max	%

**5.0 OSCILLATOR OUTPUT - CS OPTION**

Line	Parameter	Test Condition	Value	Unit
5.1	Output waveform	DC coupled Clipped sine-wave output (Note 5)		
5.2	Output voltage level	At minimum supply voltage (Note 3)	0.8 min	V
5.3	Output load resistance	Operating range	9 to 11	k $\Omega$
5.4	Output load capacitance	Operating range	9 to 11	pF
5.5	Start up time (amplitude)	Time taken for output to reach 90% of specified output level	1 max	ms
5.6	Settling time (frequency)	Time taken for frequency to reach specified calibration tolerance (Note 6)	10 max	ms

**6.0 OSCILLATOR OUTPUT - CMOS OPTION**

Line	Parameter	Test Condition	Value	Unit
6.1	Output waveform	HCMOS		
6.2	Output voltage level low	Measured with a capacitive load of 10pF	10 max	%Vcc
6.3	Output voltage level high	Measured with a capacitive load of 10pF	90 min	%Vcc
6.4	Rise and fall times	Measured with a capacitive load of 10pF	5 max	ns
6.5	Duty cycle	Measured at 50% Vcc trigger level	40 to 60	%
6.6	Output load		10 max	pF
6.7	Settling time (frequency)	Time taken for frequency to reach specified calibration tolerance (Note 6)	10 max	ms

**7.0 SSB PHASE NOISE**

Line	Parameter	Test Condition	Value	Unit
7.1	SSB phase noise power density at 1Hz offset	Typical value for a 10.0MHz Oscillator with 10nF external filter capacitor at 25°C. CMOS output	-75	dBc/Hz
7.2	SSB phase noise power density at 10Hz offset	Typical value for a 10.0MHz Oscillator with 10nF external filter capacitor at 25°C. CMOS output	-98	dBc/Hz
7.3	SSB phase noise power density at 100Hz offset	Typical value for a 10.0MHz Oscillator with 10nF external filter capacitor at 25°C. CMOS output	-127	dBc/Hz
7.4	SSB phase noise power density at 1kHz offset	Typical value for a 10.0MHz Oscillator with 10nF external filter capacitor at 25°C. CMOS output	-147	dBc/Hz
7.5	SSB phase noise power density at 10kHz offset	Typical value for a 10.0MHz Oscillator with 10nF external filter capacitor at 25°C. CMOS output	-152	dBc/Hz
7.6	SSB phase noise power density at 100kHz offset	Typical value for a 10.0MHz Oscillator with 10nF external filter capacitor at 25°C. CMOS output	-155	dBc/Hz
7.7	SSB phase noise power density at 1MHz offset	Typical value for a 10.0MHz Oscillator with 10nF external filter capacitor at 25°C. CMOS output	-157	dBc/Hz

**8.0 ENVIRONMENTAL**

Line	Parameter	Description
8.1	Shock	Half sine wave acceleration of 100G peak amplitude for 6ms duration, 3 cycles each plane. IEC 60068-2-27.
8.2	Humidity	After 48 hours at 85°C ± 2°C 85% relative humidity non-condensing (Note 7).
8.3	Thermal shock	Exposed at -40°C for 30 minutes then to 85°C for 30 minutes constantly for a period of 5 days (Note 7).
8.4	Vibration	10G RMS from 30Hz to 1500Hz random in each of the 3 axis for 4 hours, total 12 hours (Note 7).
8.5	Storage temperature	-40 to 85°C.

**9.0 MARKING**

Line	Parameter	Description
9.1	Type	Engraved.
9.2	Line 1	R and product code.
9.3	Line 2	Pin 1 and date code.

**10.0 MANUFACTURING INFORMATION**

Line	Parameter	Description
10.1	Reflow	Solder reflow processes as per attached profile.
10.2	Packaging description	Tape and reel. Standard packing quantity is 2000 units per reel

**11.0 SPECIFICATION NOTES**

Line	Parameter	Description
11.1	Note 1	Temperature varied at maximum of 1°C per minute. Control voltage held at midpoint.
11.2	Note 2	Parts should be shielded from drafts causing unexpected thermal gradients. Temperature changes due to ambient air currents on the oscillator can lead to short term frequency drift.
11.3	Note 3	Specified for load stated in oscillator output section.
11.4	Note 4	VCO of 4.5V only applicable when Vcc of 5.0V is applied.
11.5	Note 5	For AC coupling, an external capacitor (greater or equal 1nF) is required.
11.6	Note 6	Specification assumes that no phase noise filtering. If low phase noise is required, frequency settling time will be extended. Full details are available from your Rakon sales office.
11.7	Note 7	The environmental condition will cause less than 1ppm shift in frequency measured at 25°C.

**Drawing Name: RTX5032A Model Drawing**

MODEL DRAWING

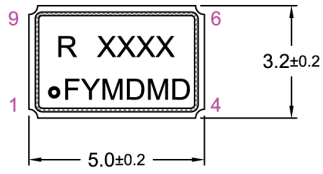

FRONT VIEW

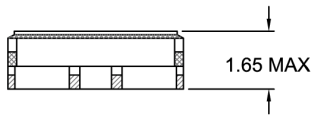

SIDE VIEW

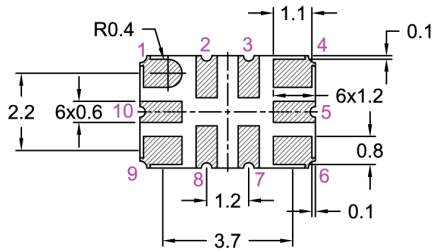

BOTTOM VIEW

MARKING EXAMPLE

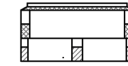
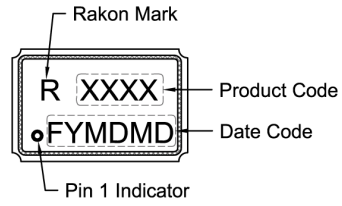

END VIEW

PIN CONNECTIONS

Without VC		With VC	
Filter Enabled	Filter Disabled	Filter Enabled	Filter Disabled
1 NC	1 NC	1 VCO	1 VCO
2 NC	4 GND	2 NC	4 GND
3 NC	6 RF OUT	3 NC	6 RF OUT
4 GND	9 VCC	4 GND	9 VCC
5 NC		5 NC	
6 RF OUT		6 RF OUT	
7 VC FILTER		7 VC FILTER	
8 NC		8 NC	
9 VCC		9 VCC	
10 NC		10 NC	

RECOMMENDED PAD LAYOUT - FILTER ENABLED

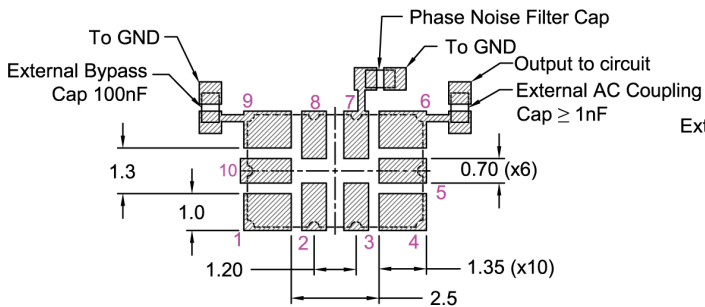

RECOMMENDED PAD LAYOUT - FILTER DISABLED

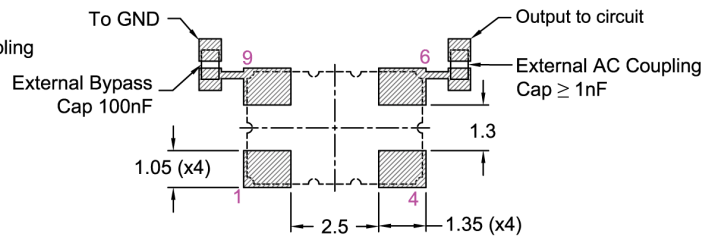

TITLE: RTX5032A MODEL

RELATED DRAWINGS:

FILENAME: CAT569

REVISION: B

DATE: 22-Aug-11

SCALE: 5 : 1

Millimetres

TOLERANCES:

XX =

X.X = ±0.2

X.XX = ±0.13

X.XXX =

X° =

Hole =



© 2009 Rakon Limited

**Drawing Name: RTX5032 Series Test Circuit**

NO VOLTAGE CONTROL INPUT:

C1: 100nF.  
F1: A ferrite bead or a resistor between 22Ω ~ 47Ω recommended.

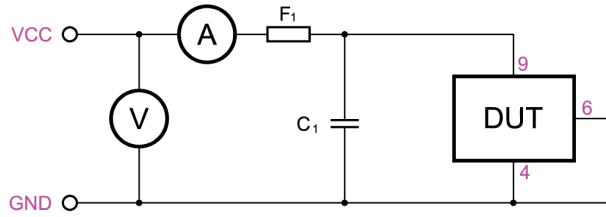

VOLTAGE CONTROL INPUT:

C1: 100nF.  
F1: A ferrite bead or a resistor between 22Ω ~ 47Ω recommended.

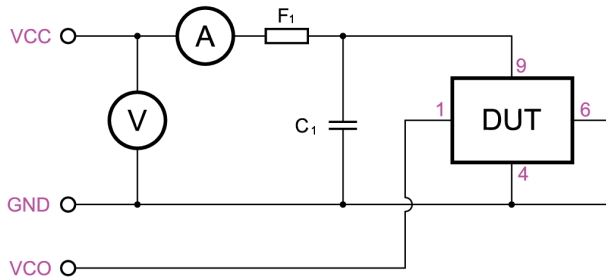

CLIPPED SINEWAVE OUTPUT:

C2: ≥1nF  
RL: 10k  
CT: CL + C3 (C3 - Oscilloscope probe capacitance)  
CT as stated in OSCILLATOR OUTPUT section

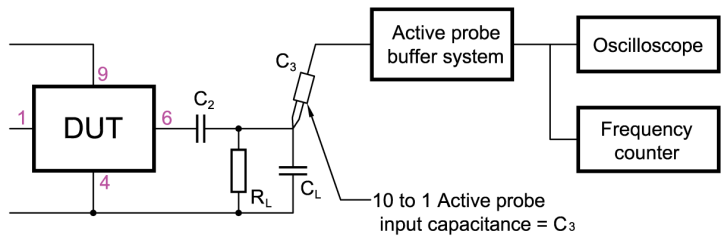

CMOS OUTPUT:

CT: CL + C2 (C2 - Oscilloscope probe capacitance)  
CT as stated in OSCILLATOR OUTPUT section

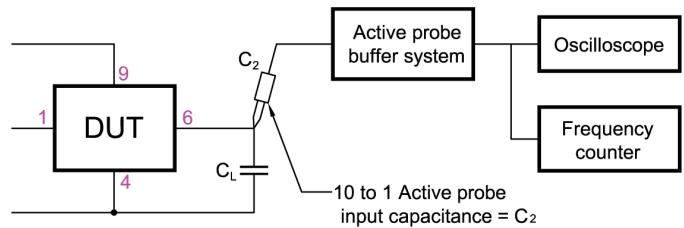

TITLE: RTX5032 SERIES TEST CIRCUIT

FILENAME: CAT571

RELATED DRAWINGS:

REVISION: A

DATE: 02-Dec-10

SCALE: NTS

Millimetres



© 2009 Rakon Limited

**Drawing Name: I(V)T5300 Series Tape & Reel**

TAPE DETAIL (SCALE 2 : 1)

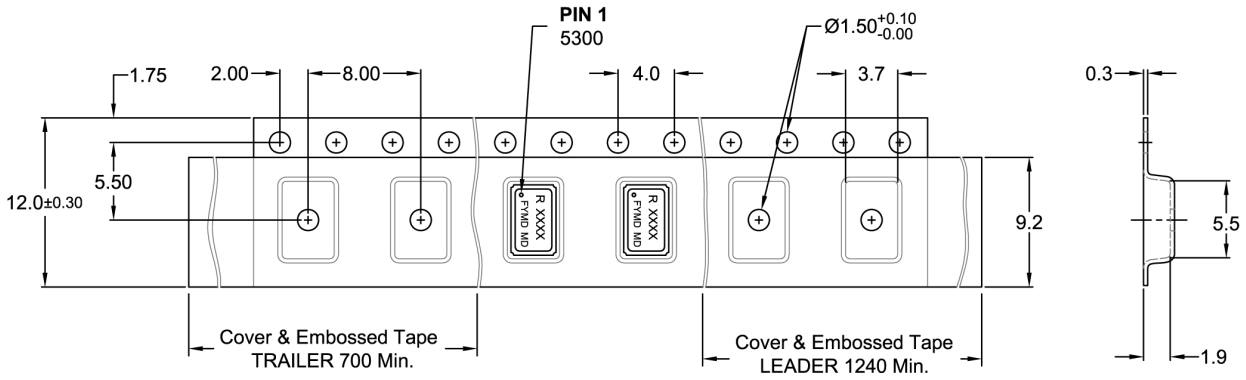

REEL DETAIL (SCALE 1 : 2.5)

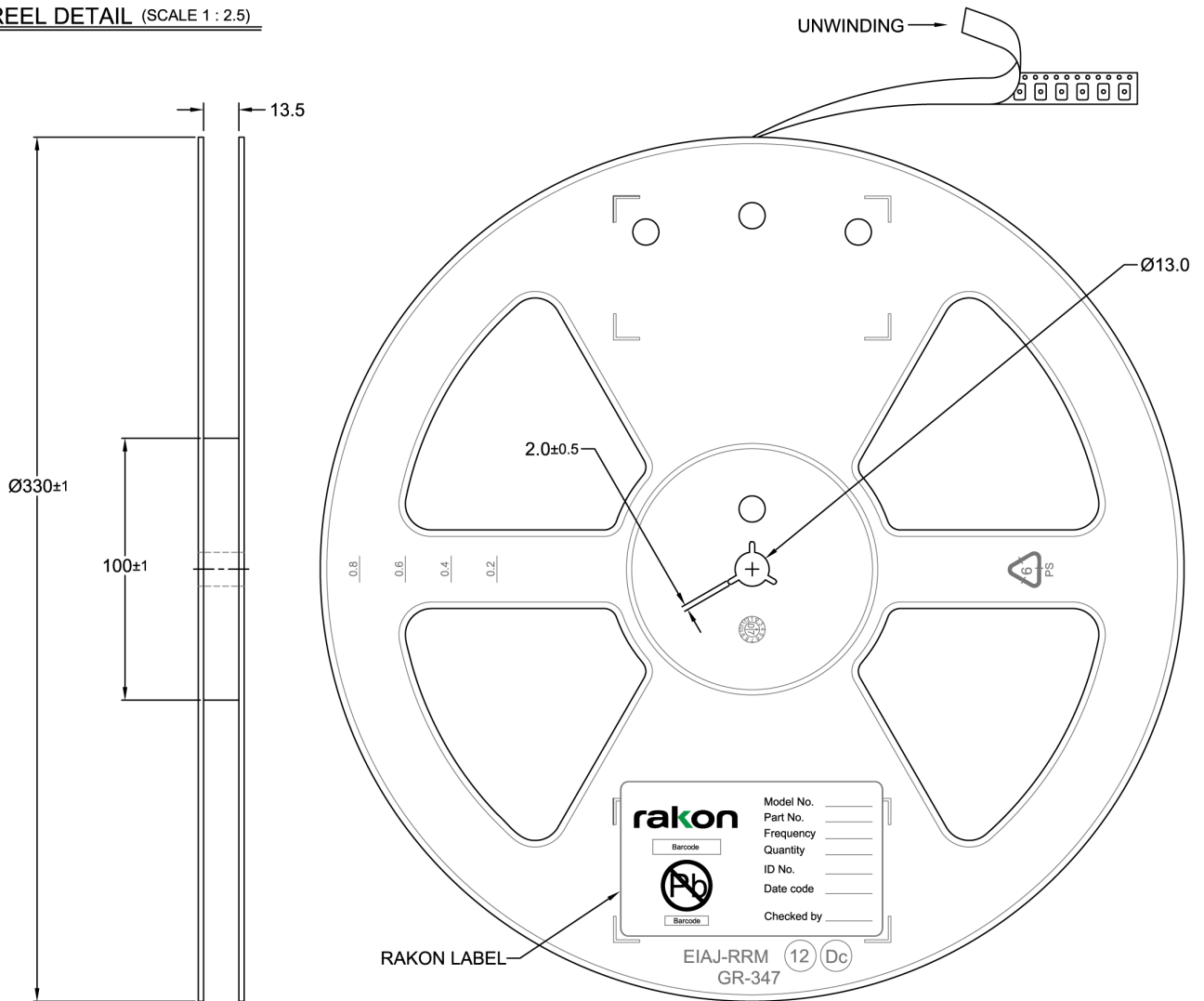

TITLE: 5032 SERIES TAPE REEL

RELATED DRAWINGS:

FILENAME: CAT449

REVISION: F

DATE: 22-Aug-11

SCALE: 2 : 1

Millimetres

TOLERANCES:

XX =  
 X.X = ±0.1  
 X.XX = ±0.05  
 X.XXX =  
 X° =  
 Hole =



© 2009 Rakon Limited

**Drawing Name: Pb-Free Reflow**

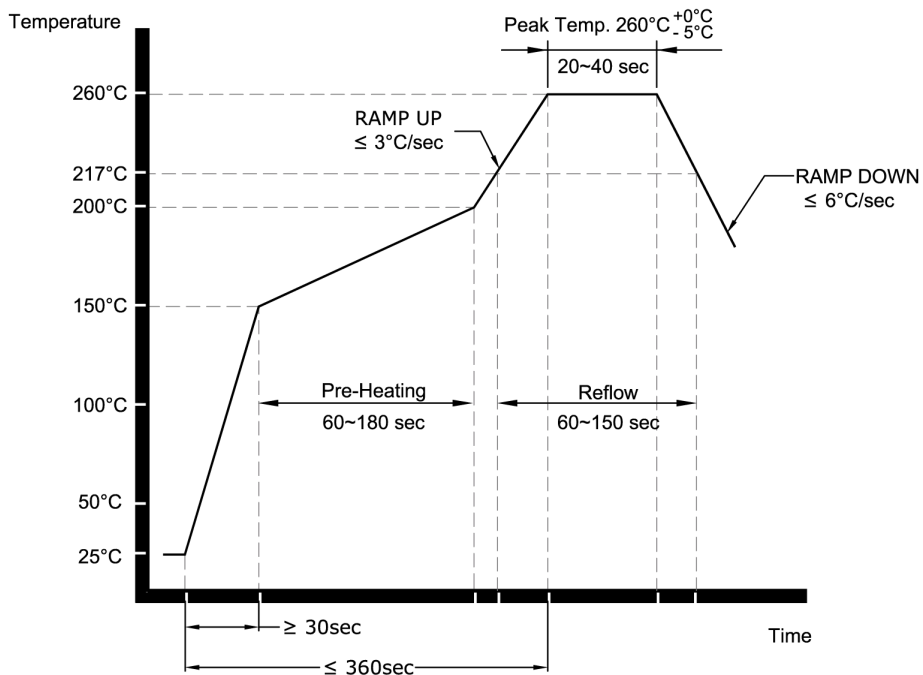

**NOTE:**

The product has been tested to withstand the Reflow Profile shown. The Reflow Profile used to solder Rakon products is determined by the solder paste Manufacturer's specification. It is recommended that the Reflow Profile used does not exceed the one shown above.

TITLE: Pb-FREE REFLOW

RELATED DRAWINGS:

FILENAME: CAT541

REVISION: B

DATE: 05-Sep-11

SCALE: NTS

Millimetres



© 2009 Rakon Limited