

SP3010 Series 0.45pF Diode Array

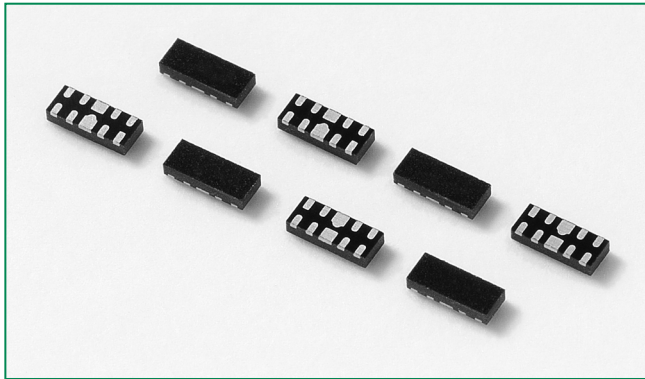

Pinout

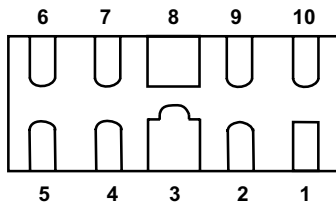

*Pins 6, 7, 9, 10 are not internally connected but should be connected to the trace.

Functional Block Diagram

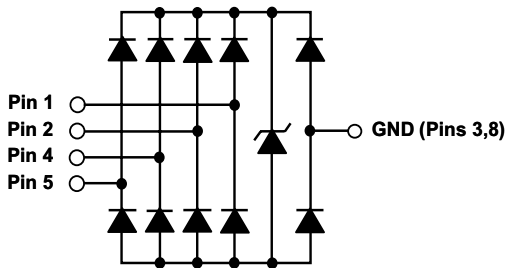

Additional Information



Datasheet



Resources



Samples

Life Support Note:

Not Intended for Use in Life Support or Life Saving Applications

The products shown herein are not designed for use in life sustaining or life saving applications unless otherwise expressly indicated.

Description

The SP3010 integrates 4 channels of ultra-low capacitance rail-to-rail diodes and an additional zener diode to provide protection for electronic equipment that may experience destructive electrostatic discharges (ESD). This robust device can safely absorb repetitive ESD strikes at the maximum level specified in the IEC 61000-4-2 international standard (Level 4, ±8kV contact discharge) without performance degradation. The extremely low loading capacitance also makes it ideal for protecting high speed signal pins such as HDMI, USB3.0, USB2.0, and IEEE 1394.

Features

- ESD, IEC 61000-4-2, ±8kV contact, ±15kV air
- EFT, IEC 61000-4-4, 40A (5/50ns)
- Lightning, IEC 61000-4-5 2nd edition, 3A (t_p=8/20µs)
- Low capacitance of 0.45pF (TYP) per I/O
- Low leakage current of 0.1µA (TYP) at 5V
- Small form factor µDFN (JEDEC MO-229) package saves board space
- RoHS compliant and lead-free

Applications

- LCD/PDP TVs
- DVD Players
- Desktops
- MP3/PMP
- Set Top Boxes
- Mobile Phones
- Notebooks
- Digital Cameras

Application Example

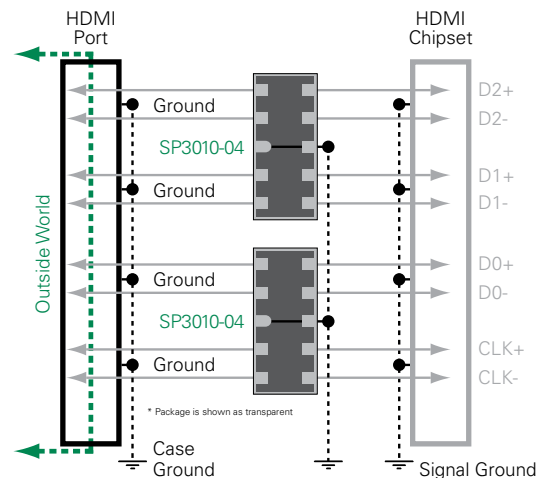

Absolute Maximum Ratings

Symbol	Parameter	Value	Units
I_{PP}	Peak Current ($t_p=8/20\mu s$)	3.0	A
T_{OP}	Operating Temperature	-40 to 125	°C
T_{STOR}	Storage Temperature	-55 to 150	°C

CAUTION: Stresses above those listed in "Absolute Maximum Ratings" may cause permanent damage to the device. This is a stress only rating and operation of the device at these or any other conditions above those indicated in the operational sections of this specification is not implied.

Electrical Characteristics ($T_{OP}=25^\circ C$)

Parameter	Symbol	Test Conditions	Min	Typ	Max	Units
Reverse Standoff Voltage	V_{RWM}	$I_R \leq 1\mu A$			6.0	V
Reverse Leakage Current	I_{LEAK}	$V_R=5V$, Any I/O to GND		0.1	0.5	μA
Clamp Voltage ¹	V_C	$I_{PP}=1A$, $t_p=8/20\mu s$, Fwd		10.8		V
		$I_{PP}=2A$, $t_p=8/20\mu s$, Fwd		12.3		V
Dynamic Resistance	R_{DYN}	$(V_{C2} - V_{C1}) / (I_{PP2} - I_{PP1})$		1.5		Ω
ESD Withstand Voltage ¹	V_{ESD}	IEC61000-4-2 (Contact)	± 8			kV
		IEC61000-4-2 (Air)	± 15			kV
Diode Capacitance ¹	$C_{I/O-GND}$	Reverse Bias=0V		0.45		pF

Note: ¹ Parameter is guaranteed by design and/or device characterization.

Capacitance vs. Bias Voltage

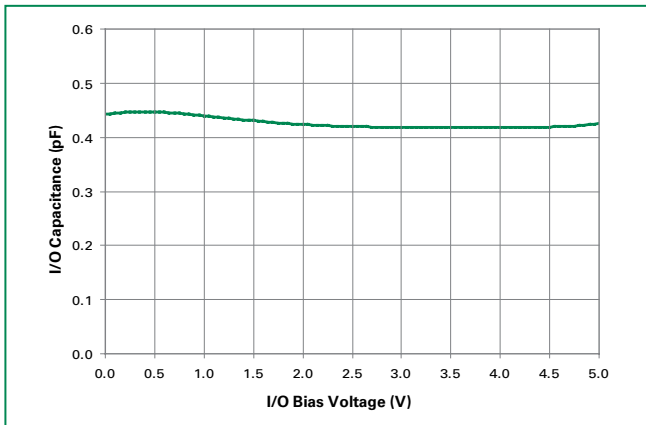

Insertion Loss (S21) I/O to GND

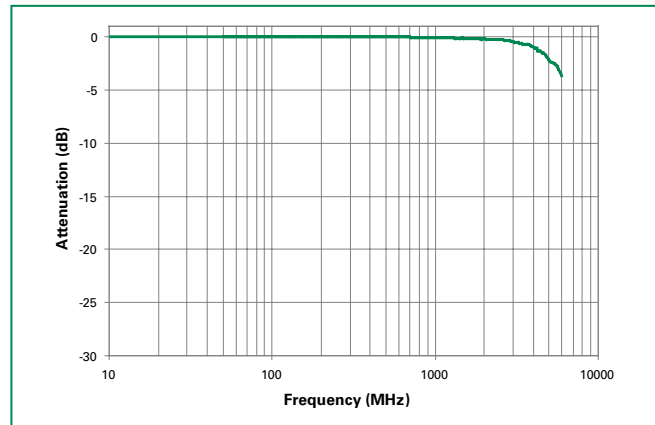

Clamping Voltage vs. I_{PP}

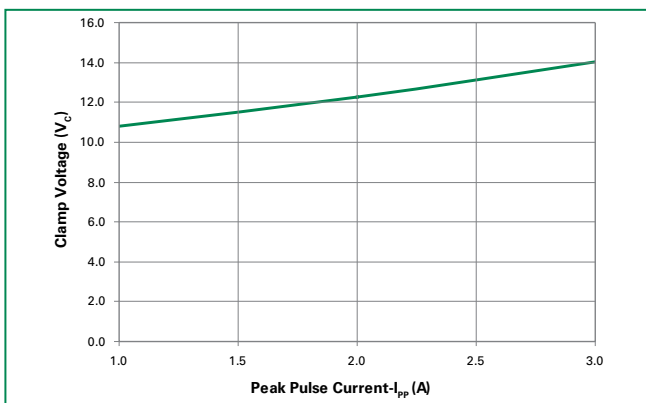

Pulse Waveform

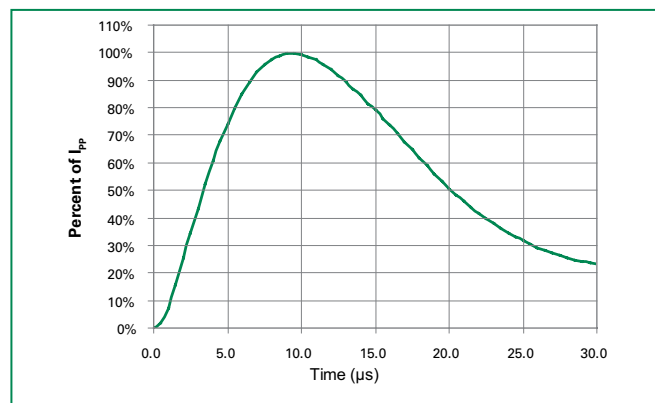

Soldering Parameters

Reflow Condition		Pb – Free assembly
Pre Heat	- Temperature Min ($T_{s(min)}$)	150°C
	- Temperature Max ($T_{s(max)}$)	200°C
	- Time (min to max) (t_s)	60 – 180 secs
Average ramp up rate (Liquidus) Temp (T_L) to peak		3°C/second max
$T_{s(max)}$ to T_L - Ramp-up Rate		3°C/second max
Reflow	- Temperature (T_L) (Liquidus)	217°C
	- Temperature (t_l)	60 – 150 seconds
Peak Temperature (T_p)		260 ^{+0/-5} °C
Time within 5°C of actual peak Temperature (t_p)		20 – 40 seconds
Ramp-down Rate		6°C/second max
Time 25°C to peak Temperature (T_p)		8 minutes Max.
Do not exceed		260°C

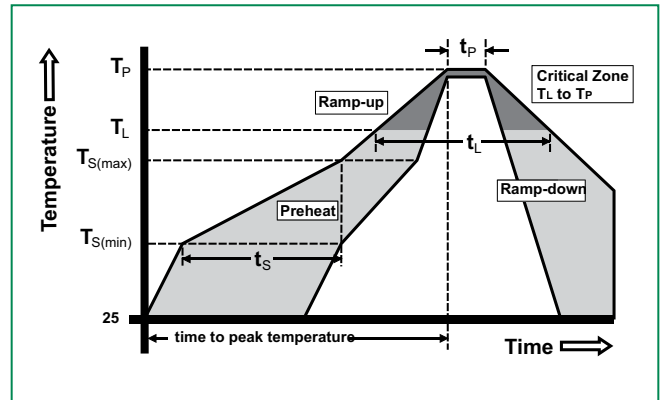

Part Numbering System

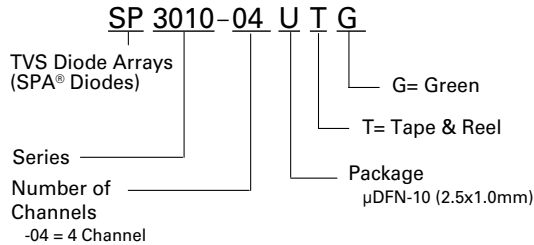

Part Marking System

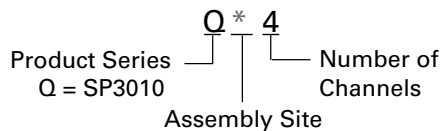

Product Characteristics

Lead Plating	Pre-Plated Frame
Lead Material	Copper Alloy
Lead Coplanarity	0.0004 inches (0.102mm)
Substitute Material	Silicon
Body Material	Molded Epoxy
Flammability	UL 94 V-0

Notes :

1. All dimensions are in millimeters
2. Dimensions include solder plating.
3. Dimensions are exclusive of mold flash & metal burr.
4. Blo is facing up for mold and facing down for trim/form, i.e. reverse trim/form.
5. Package surface matte finish VDI 11-13.

Ordering Information

Part Number	Package	Marking	Min. Order Qty.
SP3010-04UTG	μ DFN-10	Q*4	3000

Embossed Carrier Tape & Reel Specification – μ DFN-10

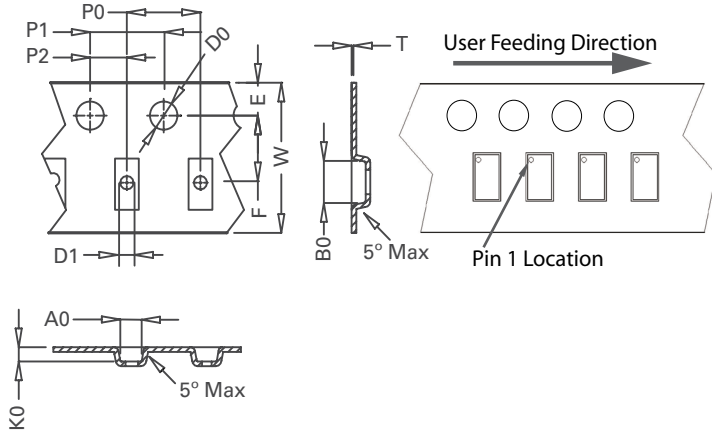

Package	μ DFN-10 (2.5x1.0x0.5mm)
Symbol	Millimeters
A0	1.30 ± 0.10
B0	2.83 ± 0.10
D0	∅ 1.50 + 0.10
D1	∅ 1.00 + 0.25
E	1.75 ± 0.10
F	3.50 ± 0.05
K0	0.65 ± 0.10
P0	4.00 ± 0.10
P1	4.00 ± 0.10
P2	2.00 ± 0.05
T	0.254 ± 0.02
W	8.00 + 0.30 / - 0.10

Package Dimensions – μ DFN-10 (2.5x1.0x0.5mm)

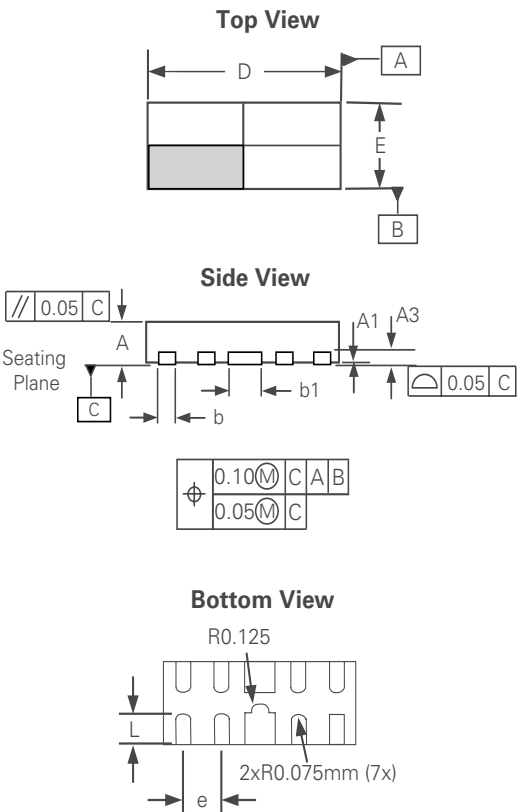

Package	μ DFN-10 (2.5x1.0x0.5mm)					
JEDEC	MO-229					
Symbol	Millimeters			Inches		
	Min	Nom	Max	Min	Nom	Max
A	0.48	0.515	0.55	0.019	0.020	0.021
A1	0.00	--	0.05	0.000		0.022
A3	0.125 Ref			0.005 Ref		
b	0.15	0.20	0.25	0.006	0.008	0.012
b1	0.35	0.40	0.45	0.014	0.016	0.018
D	2.40	2.50	2.60	0.094	0.098	0.102
E	0.90	1.00	1.10	0.035	0.039	0.043
e	0.50 BSC			0.020 BSC		
L	0.30	0.365	0.43	0.012	0.014	0.016

Recommended Soldering Pad Layout

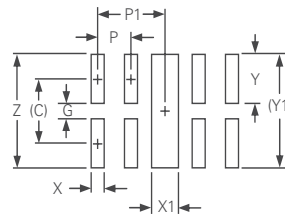

Soldering Pad Layout Dimensions

	Inch	Millimeter
C	(0.034)	(0.875)
G	0.008	0.20
P	0.020	0.50
P1	0.039	1.00
X	0.008	0.20
X1	0.016	0.40
Y	0.027	0.675
Y1	(0.061)	(1.55)
Z	0.061	1.55

Alternative Soldering Pad Layout

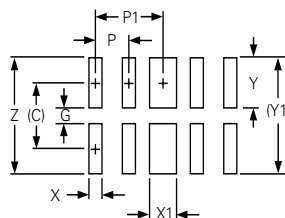

Disclaimer Notice - Information furnished is believed to be accurate and reliable. However, users should independently evaluate the suitability of and test each product selected for their own applications. Littelfuse products are not designed for, and may not be used in, all applications. Read complete Disclaimer Notice at www.littelfuse.com/disclaimer-electronics.