

LMSC
7956-468
C-2-P

LMSC-A956468
25 AUGUST 1969
CODE 9999

AD750 290

NUCLEAR RADIATION HARDENING FOR ELECTRONIC COMPONENTS

LMSC LIBRARY PROPERTY - PALO ALTO
Return to LMSC. Do not
transmit to another person or office.

DISTRIBUTION STATEMENT A
Approved for public release;
Distribution Unlimited

Reproduced by
**NATIONAL TECHNICAL
INFORMATION SERVICE**
U S Department of Commerce
Springfield VA 22151

LOCKHEED MISSILES & SPACE COMPANY
A GROUP DIVISION OF LOCKHEED AIRCRAFT CORPORATION
SPACE SYSTEMS DIVISION • SUNNYVALE, CALIFORNIA

LMSC-A956468
25 August 1969
Code 9999

LMSC LIBRARY PROPERTY - PALO ALTO
Return to the person to whom it was loaned. Do not
transmit to another person or office.

NUCLEAR RADIATION HARDENING FOR
ELECTRONIC COMPONENTS

by

EUGENE R. HNATEK
Electrical Power Systems Engineer, D62/25

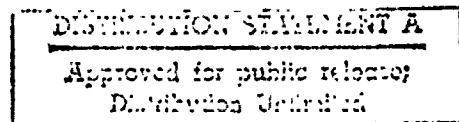
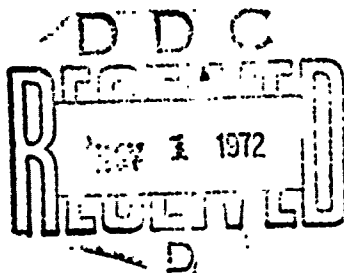

FOREWORD

This document comprises a survey of the causes and effects of a radiation environment on various electronic components, and the techniques that must be employed to harden these devices against radiation.

In applying radiation hardening techniques to electronic equipment and components, the requirement for such hardening often conflicts with both the equipment's electrical performance and physical requirements. Among these requirements are frequency response, device current ratings, switching speed efficiency, weight and volume (size). Thus tradeoffs must be made. Some guidelines are included here for establishing tradeoffs for specific designs.

Preceding page blank

CONTENTS

	<u>Page</u>
FOREWORD	iii
ILLUSTRATIONS AND TABLES	vii
SUMMARY	1
INTRODUCTION	3
TYPES OF RADIATION	4
ELECTRONIC COMPONENT RADIATION	10
Semiconductors	11
Transient Effects	11
Bipolar Transistors	12
Field-Effect Transistors	15
Junction FET	17
Metal Oxide FET	17
Diodes	18
Silicon Controlled Rectifiers	18
Permanent Effects	20
Bulk Effects	20
Radiation Sources	21
Radiation Dosage	22
Effect of Radiation on Semiconductor Device Parameters	24
Design of Radiation-Tolerant Transistor	36
Radiation Resistant Transistors	37
Field-Effect Transistors	38

Preceding page blank

v

CONTENTS (Cont.)

	<u>Page</u>
Switching and General-Purpose Diodes	38
Zener and Voltage-Reference Diodes	41
Tunnel (Esaki) Diodes	41
Semiconductor Diodes	41
Resistivity and Radiation Tolerance	42
Silicon-Controlled Devices	45
Integrated Circuits	46
Transient Effects	47
Permanent Effects	53
Hybrid Integrated Circuits	55
Radiation Hardening for Integrated Circuits	57
Passive Components	59
Resistors	59
Capacitors	62
DESIGNING RADIATION-HARDENED EQUIPMENT	64
Guidelines	65
Component Selection	65
Bias Design	65
Impedance Design	66
Other Hardening Techniques	68
RELIABILITY	68
BIBLIOGRAPHY	70

ILLUSTRATIONS

Figure		Page
1	General Relations of Radiated Particles and Rays	5
2	Construction of Typical Junction, MOS, and Thin-Film Field-Effect Transistors	16
3	Atomic Model of Silicon Atom and its Related Energy-Band Diagram	25
4	Model of pn-Junction Showing Depletion Region	27
5	Measurement of Diode Reverse Recovery Time	28
6	Models Showing Forward and Reverse Bias	30
7	Model Showing Current Carriers in a Transistor	30
8	Envelope of Current Gain (h_{FE}) Values for Ten 2N1613 Transistors Irradiated with 1-Mev Electrons	34
9	Envelope of Saturation Voltage V_{CE} (SAT) Values for Ten 2N1613 Transistors Irradiated with 1-Mev Electrons	34
10	Leakage Current (I_{CBO}) vs Integrated 1-Mev Electron Flux for Ten 2N1613 Transistors	35
11	Leakage Current (I_{EBO}) vs Integrated 1-Mev Electron Flux for Nine 2N1613 Transistors	35
12	Envelope of Forward Voltage Drop (V_{FD}) Values for Ten 1N645 Diodes Irradiated with 1-Mev Electrons	43
13	Envelope Showing Percent of Original Value of Forward Voltage Drop (V_{FD}), Ten 1N645 Diodes Irradiated with 1-Mev Electrons	43
14	Reverse Current (I_R) vs Integrated 1-Mev Electron Flux for Ten 1N645 Diodes	44
15	Signetics SE102K Digital Integrated Gate (Functional Circuit, Left; Actual Circuit, Right)	58

TABLES

Table		Page
1	Radiation-Caused Parameter Changes	25
2	Radiation Hardening vs Reliability	68

SUMMARY

The sudden upsurge of interest in the effects of radiation upon semiconductor devices is due to: (a) rumors that the Department of Defense will soon issue a directive requiring all military avionics equipment to contain radiation-hardened devices; and (b) these devices may have importance beyond their ability to withstand high-radiation influxes.

Device geometries that tolerate nuclear environments may provide higher switching speeds, lower parasitic capacitances, better temperature stability, and higher average utilization than today's conventional methods provide.

Power transistors are difficult to harden because of their construction — large geometries, low doping, and high voltages. Also, the large areas cause increased transient gamma photocurrents to flow, and the low gain-bandwidth products combined with thick base widths produce post-neutron bombardment beta degeneration. Finally, the higher $V_{CE(SAT)}$ values and large package size impede hardening too.

Discrete and integrated linears cannot tolerate wide parameter changes as well as logic devices do. Linearity must be maintained, and element ratios and stage balances (as in a differential amplifier) must be closely held.

Desirable component characteristics for hardening include small geometries: the smaller the device's active volume, the less the effects of photocurrent flow. High-level doping raises post-neutron resistivity. Low voltages accommodate higher doping levels. Gold doping strengthens saturation characteristics and lessens beta sensitivity to neutrons. High current densities and high gain-bandwidth products improve the device's post-neutron gain capability.

Other hardening measures include dielectric isolation, minimum internal base resistance and base widths, and double-diffused epitaxial construction. Silicon is preferred to germanium because of its higher resistivity.

Testing also presents some problems, depending upon hardness level requirements. For lab testing, high gamma dose rates may be simulated by flash X-ray equipment. Linear accelerators may be used for cases requiring moderate gamma levels and steady-state neutron radiation. And for high neutron delivery rates and high steady-state neutron presence, pulsed reactors can be used.

The five basic and distinct steps which are used to produce effective radiation-resistant circuits and equipment are:

1. Determine the radiation environment-its types intensity, spectrum, time, etc.
2. Define the circuits in terms of components, materials, placement of parts, pottings and coatings.
3. Choose a method of circuit analysis, one in which accuracy is intelligently traded off for simplicity and which allows for permanent damage if intense radiation is expected.
4. Apply the appropriate hardening techniques.
5. Verify performance analysis and quality for acceptance.

INTRODUCTION

The extent of space radiation damage to electronic components and materials is a function of the total environment including electrical biases, temperature ambient atmosphere, load impedances, and other factors besides the radiation. Prediction of expected electronic equipment performance for a specific space application must be based upon the expected total environment for each electronic component of material at its planned location in the equipment.

The space radiation effects observed for electronic components and materials are due to absorption of energy from the radiation which causes either ionization of the target atoms or displacement of these atoms. The ionization effects are generally considered to be temporary or at most semipermanent, in the sense that they disappear immediately or within a relatively short time after irradiation ceases. Permanent effects are associated with the atomic displacements, which result in disordering of crystal lattices in the electronic materials and in the materials that constitute electronic components.

Most semiconductor devices are orders of magnitude more sensitive to radiation than are other electronics materials and components such as resistors, capacitors, coils and insulators. For space radiation levels, the most significant effects in semiconductors are caused by radiation induced lattice defects acting as recombination centers and reducing the minority carrier lifetime. Radiation induced ionization at or near semiconductor surfaces, particularly in junction regions, may cause significant leakage currents and result in part failure for some applications.

TYPES OF RADIATION

The atomic particles which are basic to radiation studies are the alpha (α) particle, beta (β) particle, neutrons and protons. In addition there are pertinent electromagnetic waves such as X-rays and gamma (δ) rays. (See Figure 1.)

Alpha particles are helium nuclei or ions, each carrying two positive charges. Each ion has a mass about four times that of a proton, which is large when talking of particles. The size of a particle is so small in relation to other distances that it can be considered a mass point with zero extension. Such a mass point is called a "particle" in mechanics. Alpha particles travel a few thousand miles per second and have energy as high as 10 million electron volts. However, a single sheet of writing paper will stop an alpha particle because of the particle's large size and positive charge.

Beta particles are high-energy (therefore, high-speed) electrons. Beta particles have a negative charge and are about 100 times more penetrating than alpha particles. They have widely varying speeds; some travel at nearly the speed of light. They can pass through approximately a millimeter of aluminum because of their high speeds.

Gamma rays are high-energy photons, with a wavelength of 0.5\AA to 0.005\AA , with energy range that overlaps that of X-rays. They are in effect electromagnetic waves. Gamma rays have no electrical charge and, therefore, can penetrate the nucleus of an atom because the electric field about the

Type of Radiation	Particle Size	Wave Length	Mass	Charge	Radiation Source	Depth of Penetration in Silicon	Effect on Silicon
ELECTRON (e) ⊖	Not Determined $10^{-14}m$	N/A	$9.1 \times 10^{-28}g$	-	Hot filament	< Beta	Surface damage
BETA (β) ⊖	Same as electron	N/A	Same as electron except for $E = mc^2$ K.E. >>electron	-	Decay of radioactive nucleus	<10 microns	Surface damage
PROTON (p) ⊕	$3 \times 10^{-15}m$	N/A	$1.67 \times 10^{-24}g$	+	Ionizing hydrogen atoms	$\beta > p > \alpha$	Surface damage
ALPHA (α) ⊕ + \oplus + \oplus	$4n$	N/A	$6.7 \times 10^{-24}g$	++ (2p 2n)	Decay of radioactive nucleus	Negligible	Negligible
NEUTRON (n) ⊕	$3 \times 10^{-15}m$	N/A	$1.67 \times 10^{-24}g$	None	Nuclear reaction	Tens of microns	Bulk damage
X-RAY ~~~~~	N/A	10^{-9} to $10^{-12}m$	No real mass	None	Electron collisions with large atom nucleus	Meters	Negligible
GAMMA RAY ~~~~~	N/A	$10^{-11}m$	No real mass	None	Collisions of nuclear particles	Meters	Negligible

Figure 1 General Relations of Radiated Particles and Rays.

atom exerts no influence on the ray. Most pure radioactive substances emit gamma rays accompanied by either alpha particles or beta particles, but since substances are seldom pure, one usually finds all three type of radiation present.

Neutrons, like gamma rays, have no electrical charge. The mass of a neutron is slightly greater than that of a proton. As a frame of reference, a proton has a mass 1836 times that of an electron. The diameter of an electron is no more than 10^{-14} meters. Neutrons can penetrate several millimeters of lead for the same reason a gamma ray can, i.e., no electrical interaction with electrons and nuclei in matter. However, neutrons, because of their mass, can do considerable damage to the nucleus of an atom, including the splitting of nuclei to cause fission and the fantastic release of energy, as in an atomic explosion.

Fast neutrons are not as numerous as alpha and beta particles. They are produced as a result of a complicated nuclear reaction, and there is no other source.

Radioactive material decays to a more stable form (or equilibrium condition) by a process of losing mass from its nucleus. This is a self-starting process. A basic principle of atomic or nuclear physics is that no energy can be released without a corresponding reduction in mass.

It turns out that all radioactive materials have a large atomic number, which means a larger number of positively charged protons in the nucleus. The distinguishing characteristic of radioactive materials from other elements of large atomic number is that particles in the nucleus obtain sufficient energy (in addition to the repelling force of like-charge protons) to overcome the binding energy of the nucleus. This decay or disintegration ultimately results in the emission of alpha and beta particles.

Nuclear radiation in space stems from one of three environments: (a) natural space radiation such as the Van Allen Radiation Belt, cosmic and gamma rays, etc., (b) nuclear propulsion systems and (c) nuclear explosion environment.

The effects of the Nuclear Explosion Radiation Environment have in recent years received much attention, especially since the Starfish high-altitude nuclear explosion in 1962 led to some damage to spacecraft in orbit at that time.

The radiation environment produced by a nuclear-weapon burst has as its most distinguishing characteristic the fact that it is a transient environment as contrasted with the steady-state environment associated with either a nuclear reactor or with the space environment. The term transient as used here is to be understood as covering pulse times produced by a nuclear explosion or a nuclear explosion simulation facility and will vary from nanoseconds to a few milliseconds. It should also be noted that the word transient refers to the time during which the environment lasts and not the time during which its effects last, since the effects may be either permanent or temporary. The transient nature of the environment leads to significant differences in the response of materials and components to this environment as opposed to the steady-state environments.

There are four types of nuclear radiation which influence military equipment design: these are prompt, (transient or pulses) initial, steady state and residual. However, only the first two are of major concern. Residual radiation from fallout is relatively low in intensity and usually will not damage hardware. The steady state environments of space and nuclear propulsion systems generally do not require much radiation hardening because of their minimal effects on hardware.

Prompt radiation, generally gamma rays, is emitted from explosions as an intense microsecond burst, which decays fairly rapidly. A one megaton high altitude explosion can produce a 1 microsecond gamma dose of 10^7 roentgens/sec 100 miles away. In such an environment, electronic equipment may absorb as much as 10^6 to 10^{12} rads of prompt radiation.

Initial radiation consists of gamma rays and neutrons delayed in transit in comparison to the almost instantaneously propagated prompt energy.

Neutron flux causes most of the permanent damage to electronic components and materials. Gamma pulses and flux generally cause transient effects. These can be severe, especially at high altitudes.

Pulsed nuclear radiation produced by a nuclear detonation includes both neutrons and gamma rays. The neutrons are usually considered in three groups: (1) thermal (~ 0.025 ev), (2) epithermal, and (3) fast (100 kev and greater), fast neutrons being the primary cause of radiation damage in electronics. Gamma rays of interest with respect to electronics have energies that range between 100 kev and 5 Mev. In addition to these primary radiations from nuclear detonation, energetic electrons are produced as secondaries from the interaction of gamma rays with matter; they are also frequently produced by pulsed-radiation simulation devices.

The types of effects produced by pulsed nuclear radiation are (1) displacement, (2) ionization, (3) chemical, and (4) secondary emission. Displacement is caused by close collisions between incident nuclear particles and atoms located in crystalline lattices, resulting in the displacement of the struck atom, and possibly others, from its usual lattice site. The property in semiconductors most rapidly changed by the displacement effect is the minority-carrier lifetime, which in transistors is manifested as a change in forward current gain. Ionization effects, primarily increased conductivity, are the manifestations of free electrons and ions produced by the interaction of radiation with atomic electrons. Chemical effects refer to changes in molecular composition, i.e., rearrangement of chemical bonds, that frequently accompany the recombination processes following ionization. The secondary emission of electrons can result in what is called an "internal electromagnetic pulse" (EMP).

LMSC-A956468

For exposures of interest, in which the radiation is produced by a nuclear detonation, some simplifying assertions can be made:

- (1) Displacement effects are of concern only in semiconductor devices and a few other devices, such as precision quartz crystals, which depend upon a very high degree of crystal regularity for proper functioning.
- (2) Chemical effects are of little concern because, at the exposures of interest, the changes in electrical properties attributable to chemical radiation effects are too small to be of practical significance.

ELECTRONIC COMPONENT RADIATION

Most high-population components are susceptible to permanent radiation damage. These include transistors, diodes, bulk integrated and thin-film circuits, capacitors and resistors. But their susceptibility varies with device and construction. Metal-film and wire-wound resistors easily withstand a flux of more than 10^{16} n/cm². So do certain glass, mica and ceramic capacitors and many insulating materials. Transformers, solenoids, relays and servos can also be built to survive 10^{16} n/cm².

Semiconductor devices are the problem components. They depend on their structure, crystal lattice and impurity proportions for good operation. These characteristics are easily altered by either an integrated gamma flux dose, accumulated in a short burst or high intensity, or a lower-intensity neutron flux dose over a longer period.

The rectifying properties of semiconductor diodes are permanently affected when radiation decreases the backward-to-forward resistance ratio. Because a bipolar transistor usually consists of two diodes back to back, its radiation-damage threshold is about 10 times lower than that of a diode.

A fast-neutron flux of 10^{14} n/cm² permanently reduces the forward current gain of quality 400 Mc silicon transistors to between 0.5-0.7 of their initial gain. Similarly, silicon controlled rectifiers, having three junctions, appear to be about 10 times more susceptible to radiation than transistors.

Majority-carrier devices such as tunnel diodes and field-effect transistors appear to be generally more resistant to permanent damage than minority-carrier components. However, tunnel-diode peak-to-valley ratios gradually deteriorate under radiation, and the mutual conductance of field-effect transistors falls off.

Transient damage to electronic components is a greater hazard than permanent damage. It is usually a rate effect, caused principally by gamma flux not intense enough to damage permanently but capable of producing malfunctions. The energy deposited in many electronic materials by transient radiation produces electron-hole pairs, Compton and photoelectric scattering, internal and external ionization and atomic displacements and nuclear transmutations.

These effects, in turn, increase the conductivity of resistors and the leakage of insulators; they also inject currents into active and passive components. Current injection into base regions is the main cause of damage to transistors. The current injected in the base is multiplied by the transistor's beta.

The characteristics of the current and voltage pulses caused by charge redistribution at low radiation-absorption levels are largely controlled by the time constants of the irradiated circuit. These levels can be as low as 10^7 to 10^9 rads/sec.

Semiconductors

Transient Effects. In nearly all electronic circuits, semiconductor devices are the components most sensitive to nuclear radiation. They not only suffer significant permanent changes before other components, but are responsible for most of the temporary short-time current and voltage pulses that perturb the system. Reduction of these effects in the devices is the most important step that can be taken by the circuit designer to increase the system's radiation tolerance.

Transient radiation may cause both transient and permanent effects. The transient effects result from nonequilibrium free-charge conditions introduced through ionization phenomena resulting primarily from the electromagnetic radiation component of the weapons burst. The permanent effects are attributed to physical-property changes of the irradiated materials caused by energetic particles (neutrons and secondary electrons).

It should be noted that the transient and permanent effects are defined by the primary induced effect of the radiation. For example, the short-term currents resulting from ionization may trigger a digital state change or thermally damage a device. This phenomenon is treated as a transient effect because the permanent consequences result from circuit action or heating damage rather than from a direct radiation-induced material-property change.

The transient effects observed in semiconductor devices exposed to nuclear radiation are due to the creation of excess-charge carriers (ionization) that cause current and voltage changes. These changes do not cause permanent damage directly to the semiconductor material. However, their presence may produce permanent changes because of current overloads to some components, through loss of information stored in memory units, or by the creation of premature signals. Furthermore, such transients can cause saturation of some circuits for times that are long compared to the ionizing-radiation-pulse duration, thus causing system failure during a significant and possibly critical period.

Bipolar Transistors: When an operating transistor is exposed to transient ionizing radiation, a current pulse is observed in the external circuit. This current pulse, which may be orders of magnitude larger than that of a diode with comparable dimensions, can reach a peak value at a time later than the radiation peak, and can in some cases continue for times of the order of milliseconds.

This characteristic behavior of transistors is the result of the action of the transistor amplifying properties on the primary radiation-induced photocurrents. The electrical action of the transistor creates a secondary photocurrent that is typically greater than the primary photocurrent by the gain of the transistor. Analysis of the radiation response of a transistor involves the determination of the primary photocurrent, followed by a calculation of the magnitude and duration of secondary photocurrents under the given circuit conditions.

In transistors, the primary photocurrent is generated in five regions: in the collector- and emitter-junction depletion regions, in the base, and in the emitter and collector bodies lying within a diffusion length of the junctions. In most cases, the generation of primary photocurrent in the emitter body and within the junctions can be neglected since the emitter body and the junction volumes are a relatively small part of the total generating volume.

The secondary photocurrent is produced by the accumulation of excess majority carriers in the base region as a result of the flow of primary photocurrents across the PN junctions of the device. This excess charge, which is confined in the base by the built-in junction fields, is of such polarity as to forward bias the emitter-base junction and hence cause "normal" current to flow. The collector current thus produced is called secondary photocurrent. This collector current continues to flow until the excess charge stored in the base can either recombine with minority carriers or flow out through the external base lead.

The magnitude of the collector-current pulse will depend on the exposure rate if the radiation pulse is long compared to the transistor base and collector lifetimes, but will depend on the total exposure if the pulse is shorter than those lifetimes. This is the result of base-region storage of the charge transferred from the collector by the primary photocurrent. Since many transistors have lifetimes as long as or longer than typical nuclear-weapon pulses, the total exposure is quite often the most important factor.

Below saturation, the magnitude of the photocurrent pulse becomes greater as the collector-voltage level is increased. The magnitude and duration of the secondary-photocurrent pulse, i_{sp} , is profoundly affected by the external-circuit impedances. Larger values of collector impedance result in transistor saturation at lower collector currents, and hence, limit i_{sp} in magnitude and increase the length of the transient. Small resistive, base-emitter impedances reduce the amplitude and duration of the collector-current pulse.

Although small capacitive base-emitter impedances also reduce the amplitude of i_{sp} , they integrate the base current and produce long-term tails on the secondary photocurrent pulses.

The electrical parameter best correlated to primary photocurrent and radiation-storage time is storage time measured under high-current conditions. Transistors resistant to transient radiation effects can therefore be selected through special storage-time measurements. However, these values are not always readily available on data sheets, so other electrical parameters must sometimes be used.

Since registered transistor types are only required to meet certain electrical specifications, transistors of any one type may vary by orders of magnitude with respect to response to radiation. This situation occurs because each manufacturer may choose different types of constructions and processes for manufacturing devices that will meet the required electrical specifications. Steps to consider in selecting radiation-resistant devices are.

- (1) Give preference to silicon devices, since they appear to yield smaller photocurrents than comparable germanium devices (because of a smaller generation rate and smaller diffusion constants).
- (2) Using published electrical specifications, select devices with high cutoff frequencies indicating narrow base width.
- (3) Select devices that have low storage times. Do not depend upon published specifications. Rely instead upon actual high-current-storage-time measurements.
- (4) Select transistors with low base-spreading resistance (symbolized by various authors as R_{bs} , R_{BB} , r_B or r_{bb}) for use in hardened circuits utilizing a low base-to-emitter impedance.

- (5) Select transistors with small geometric parameters, especially junction area, consistent with circuit needs.
- (6) Give preference to gold-doped devices (gold doping reduces stored charge).

Selection of devices as outlined here does not guarantee that the device will be sufficiently radiation resistant. Where possible, the devices selected should be tested under anticipated radiation conditions. Once devices have been selected by the above criteria, the circuit designer can further minimize transient radiation effects in circuits by following certain design principles and techniques.

Field Effect Transistors: The term field-effect transistor (FET) pertains to a family of unipolar devices which have pentode-like characteristics. The three major categories within this family are the junction FET, the metal-oxide insulated-gate FET (MOSFET), and the thin-insulated-gate FET (TFT). The geometry and construction features of typical field-effect transistors are shown in Figure 2. The basic structure of the FET devices involves a source, a gate, and a drain in rough functional correspondence to the familiar cathode, grid, and plate of vacuum-tube technology.

The mechanisms by which radiation generates photocurrents in a FET are not substantially different from those in bipolar transistors and diodes. The important radiation parameters in an FET are the transient gate and drain to source currents. Possible sources of transient currents in FETs can be grouped into the following categories:

- (1) Leakage currents across PN junctions which behave like PN junction photocurrent discussed previously.
- (2) Direct modulation of the channel conductivity and mobility; usually applicable at high ($> 10^8$ R/s) exposure rates.

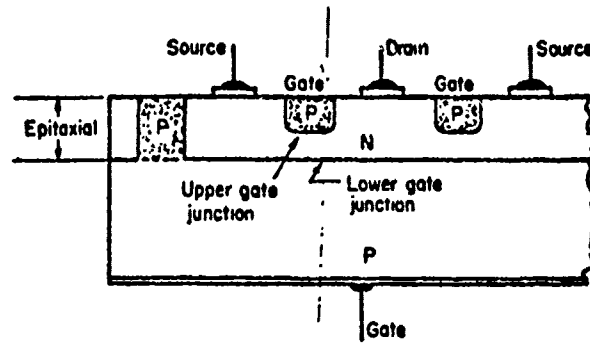

a. Junction Field-Effect Transistor

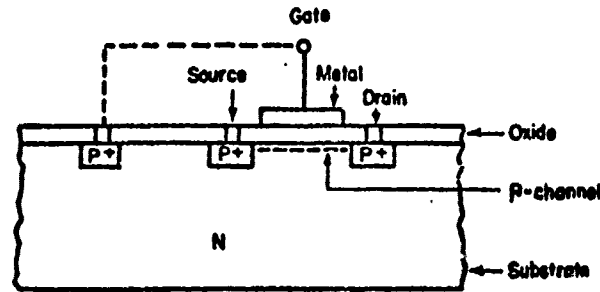

b. MOS Field-Effect Transistor

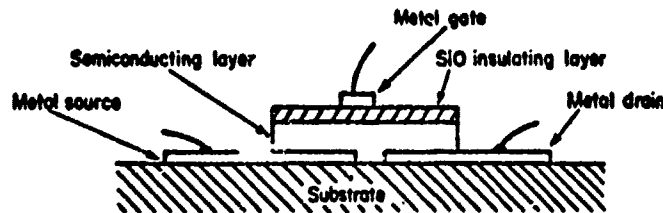

c. Thin-Film Field-Effect Transistor

Fig. 2 Construction of Typical Junction, MOS, and Thin-Film Field-Effect Transistors

- (3) Leakage currents through the gate oxide layer; applicable to the metal oxide and thin-film FETs.
- (4) Secondary emission and atmosphere ionization currents.

The transient response of specific FETs will now be discussed in turn.

Junction FET: The most important sources of transient currents in a junction FET are the depletion layer and the active volume associated with a PN junction. Like PN junction photocurrents in diodes and bipolar transistors, the gate and drain photocurrents are proportional to the exposure rate up to saturation. The transient drain current is found to be relatively independent of drain-to-source and gate-to-source voltage and is slightly higher when the gate is open than when it is shorted to the source. The gate currents have approximately the same time dependence. The build-up and decay of the photocurrent pulse depends on the lifetime and the rate of drift of charges in the channel. The lifetime in the type silicon used in field-effect transistors can be assumed to be around 1 microsecond.

Metal-Oxide FET: In contrast to the junction FET, which operates in the depletion mode only, MOS devices operate in both the depletion and enhancement mode. In the enhancement type P-channel device, a negative increment in gate voltage will induce compensating positive charges in a region at the surface of the conductive channel between source and drain. A positive increment will tend to shut the device off. A "depletion" transistor is quiescently "on" or conductive at zero gate bias. An "enhancement" transistor is quiescently "off" or nonconductive at zero gate bias.

In a transient-radiation environment, the MOS transistor exhibits two primary currents of interest, a gate ionization current, i_{pg} , and a drain-to-substrate photocurrent, i_{pd} . The gate current is a nonlinear function of gate voltage, being larger for positive bias. This behavior indicates that the primary mechanism responsible for the generation of gate current is leakage through the ionized gas surrounding the device to the case.

The response of the gate can be significantly reduced by replacing the encapsulated nitrogen (the gas normally used to fill TO-5 cans) with paraffin, or by evacuating the TO-5 can. By using a flat pack which contains a small volume of encapsulated gas instead of a TO-5 can, the gate leakage can be reduced by a factor of 10.

Diodes: Tunnel diodes are at least an order of magnitude more radiation resistant than diodes in general, since they are characterized by small geometry, heavily doped PN regions, and narrow junctions. The short-circuit photocurrent can be estimated from equations applicable to diodes. Since the lifetime of minority carriers in tunnel diodes is very short, the response of a tunnel diode to a pulse of radiation is expected to follow the radiation pulse. Normally, the width of the depletion region for tunnel diodes is so narrow that the photocurrent will consist primarily of the diffusion component.

Silicon Controlled Rectifiers: A silicon-controlled rectifier (SCR) is a solid-state semiconductor device composed of four layers of alternate-impurity semiconductor material containing three PN junctions. The SCR is an active switching element with characteristics similar to those of a gas thyatron, i.e., it will remain in a nonconducting or "off" state until turned on or "fired" by a low-level control signal on the gate. It will then remain "on" without the need for a sustaining control signal. The SCR is turned "off" by reducing its anode current to below the "dropout" level.

When a high-energy, short-duration, radiation pulse impinges upon an SCR circuit, the following effects occur:

- (1) Ionization produced in the SCR results in the creation of hole-electron pairs.
- (2) Ionization of the surrounding gas may, at the higher radiation levels, cause external leakage from one electrode to another.

- (3) Scattering of charge from the component or package by photoelectric or Compton processes causes extraneous currents to flow in the external circuitry in a manner equivalent to that of a current generator connected from some point in the component to ground.

These radiation-induced currents, like those observed in diodes and transistors, are a direct function of the junction areas, diffusion lengths, etc. and thus are difficult to predict, since values for these parameters are usually not available. Since these currents, above a certain threshold, can induce changes in the state of an SCR, it is imperative that some method be developed to predict the magnitude of these radiation-induced currents, or more specifically the radiation threshold above which switching occurs.

It has been found that the transient-radiation switching thresholds (critical radiation-exposure rate) for SCRs are functions of the radiation-pulse width. For pulse widths greater than a critical value, the exposure rate required to trigger an SCR becomes constant. This critical value is a function of the device minority-carrier lifetime and device "turn on" delay time. For pulse widths less than the critical value, the exposure rate required to trigger an SCR increases rapidly as the pulse width approaches zero.

Experiments show that the radiation sensitivity of an SCR circuit can be decreased somewhat by applying the following "rules-of-thumb":

- (1) Employ a negative gate bias.
- (2) Use the lowest practical value of gate resistor.
- (3) Place the load in the cathode rather than the anode circuitry, if possible.
- (4) Provide the lowest practical anode supply voltage $(B+)$ [$(B+) \ll V_{FB}$, where V_{FB} is the SCR forward breakover voltage].

Permanent Effects. Permanent effects as opposed to transient effects will be classified as those changes in device characteristics which persist for long periods of time as compared to the minority carrier lifetime or the circuit response. Typically the permanent change will last more than several hours at room temperature, and frequently will last so long that no significant recovery will be noticed. For the sake of continuity, however, transient annealing of the bulk damage in transistors, an important effect which is an exception to the above definition, will be discussed in this section.

Most permanent effects in semiconductor devices subjected to a nuclear-radiation pulse result from damage to the semiconductor material by energetic neutrons (> 10 keV). However, the effects of gamma radiation must not be under-estimated. In certain devices such as MOS field-effect transistors the effects of ionizing radiation can be the principal causes of failure.

Permanent effects can be grouped into two categories - bulk and surface effects. Bulk effects are changes in the device characteristics which can result from damage to the bulk material. Surface effects are changes that are generally due to radiation-induced ionization near the surface of the device. Bulk damage effects due to neutron radiation can usually be predicted within a factor of 2 while surface effects are generally unpredictable.

Bulk Effects: Bulk effects are due to gamma-ray and neutron induced lattice displacements in the bulk of the material. Fast neutrons lose energy primarily by elastic collisions with the semiconductor atoms and cause large disordered clusters to be formed within the material. Gamma radiation in contrast loses energy by creating Compton electrons which may cause lattice displacements. Since electrons have such a small mass, they primarily cause Frenkel defects (vacancy-interstitial pairs) rather than cluster of defects. Lattice damage due to gamma radiation is usually of secondary importance unless a large gamma dose ($> 10^5$ rads) is absorbed by the material.

Lattice damage acts to degrade the electrical characteristics of semiconductor devices by increasing the number of trapping, scattering, and recombination centers.

When crystals are irradiated by high-energy particles, defects result. The principal effect is to displace atoms in the crystal lattice from a regular position in an interstitial position, creating interstitial atoms, vacancies and dislocations.

Electron radiation primarily produces surface damage, while neutron bombardment has the ability to damage the bulk material. Electron radiation effects are annealed out at temperatures as low as 150°C. Neutron radiation, on the other hand, usually requires longer baking at a temperature of 200°-300°C to remove damage.

The dislocation damage in the bulk or at the surface has the effect of introducing into the crystal intermediate energy-level sites. These sites act as recombination or trap centers:

Radiation Sources: A prime requirement of radiation-tolerant devices is that they remain functional after neutron bombardment. The only real reason for discussing electron bombardment is that neutron sources are not as readily available as electron sources. Therefore, suppliers of radiation-tolerant devices use electron bombardment as an indicator of the resistance to neutron bombardment.

Neutron bombardment is about 1.5 order of magnitude more damaging than electron bombardment. An empirically derived equivalent is:

$$1.0 \times 10^{16} \text{ nvt} \approx 5 \times 10^{16} \text{ evt}$$

(Neutron) (Electron)

As was stated earlier, there is only one source of fast neutrons - a nuclear reaction. This reaction is as follows: Slow neutrons are found almost everywhere in the atmosphere. If a slow neutron strikes the atom of U_{235} , the nucleus will split, giving off two fission fragments (such as radioactive krypton and xenon) plus fast neutrons. The fast neutrons are the particles used to perform neutron bombardment. This process of controlled fission is carried out in a nuclear reactor, and the specimen being irradiated is placed so that it will be bombarded by the fast neutrons.

There are several sources of electrons. The hot filament is the most common. Here the elevated temperature of the metal supplies enough thermal energy to allow electrons to escape from the conduction band where they can move under the influence of an applied field. This process of electron generation is called thermionic emission. Generally, electrons must be accelerated to have any damaging effect.

Radiation Dosage: There are many measurement units for radiation dosage. Units used on present data sheets seem to be limited to nvt, evt and Mev units. In simplified terms, nvt is the number of neutrons per unit area, with some average velocity, for some time period. The term evt is the number of electrons per unit area with some average velocity, for some time period. Mev is 10^6 electron-volts, a unit of energy. The term flux is usually given in terms of nv or ev units, estimating the number of particles impinging per unit area with some average velocity.

Neutrons/cm² or ncm² (nvt) is the general unit of integrated neutron flux density - the total number of neutrons traversing an area in a given time.

Electrons/cm² or ecm² (evt) is the general unit of integrated electron flux density.

Neutrons/cm²/sec is the general neutron dose rate.

Roentgens is the unit of exposure dose of gammas or X-rays.

Roentgens/sec or R/sec is the basic exposure dose rate of gammas or X-rays.

Rads and rads/sec are the units of absorbed dose and absorbed dose rate of any material. One rad liberates 100 ergs per gram of absorbing material.

Data in neutrons/cm² or any of the other units cannot be precise unless the source of radiation, energy spectrum and other facts are known.

The following analogy is an attempt to give some practical meaning to these terms. You park your car in a busy parking lot for 8 hours. During this period of time it is hit in the bumpers by 100 other cars, each going 1 mph. At the end of eight hours you retrieve your car and there is no visible damage. The next day you run out of gas on the freeway and abandon your car. For 7 hours, 59 minutes everybody manages to avoid hitting your car. At the last minute, however, a hot rod going 100 mph hits your car in the back bumper. A summary of the damage is academic, but the point is this: the nvt products for both days are equal - number of impinging particles times average velocity times time. An additional descriptor, average particle energy, is needed to satisfactorily define the situation.

Similarly, most radiation dosages that can damage semiconductors are given in terms of both nvt and Mev. In order to do any damage to the specimen being irradiated, individual particles must be energetic enough to displace atoms or otherwise disrupt the crystal structure. A large number of low-energy neutrons or electrons may do no damage at all. The nvt term defines total energy, while the Mev term defines the energy of each particle being used to bombard the semiconductor.

Effect of Radiation on Semiconductor Device Parameters: Electron and neutron bombardment cause changes in device parameters that strongly resemble changes effected by gold diffusion. The discussion that follows on parameter change after radiation is easier to explain in terms of gold diffusion which closely resembles radiation effects.

Both gold atoms and radiated particles introduce intermediate energy level sites. A full understanding of this principle requires a diagram of an energy band and an atom showing electron shells. (See Figure 3.). The energy band diagram is intended to depict intrinsic silicon at 25°C with some electrons already liberated to the conduction band. The region between the valence and conduction bands is known as the forbidden energy gap, which represents the energy in electron-volts necessary to liberate an electron from the valence band of an atom into the conduction band where it is free for conduction.

The energy gap for intrinsic silicon at room temperature is 1.1 electron-volts. Actually, for the true case of a silicon crystal with impurity atoms present and external bias, the energy band looks quite different. However, to develop the basic explanation, the simple energy diagram is sufficient.

The energy band also shows the presence of gold atoms between the valence and conduction band, hence, the term "intermediate energy level." Table 1 summarizes the parameter changes after radiation.

The effective resistivity of the silicon material is increased in n-type material (for example) because there is a reduction in the number of electrons from the donor atoms. This is also because of gold atoms, at their intermediate energy level, act as recombination or trap centers and will attract and trap electrons as they move between the valence and conduction band.

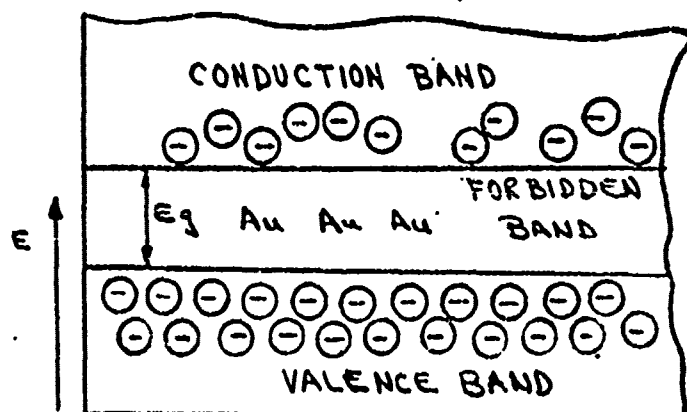

Figure 3: Atomic Model of Silicon Atom and its Related Energy-Band Diagram

Table 1
RADIATION-CAUSED PARAMETER CHANGES

Parameter	Effect	Component
Resistivity	Increased	Diodes
Breakdown Voltage (BV)	Increased	
Forward Conductance (I_F)	Decreased	
Capacitance (C_0)	Decreased	
Reverse Current (I_R)	Increased	
Reverse Recovery Time (T_{RR})	Decreased	
Collector-Emitter Saturation Voltage ($V_{CE SAT}$)	Increased	Transistors
Transistor Gain (Beta)	Decreased	
Transistor Switching Speed	Increased	
Collector-Base Current (I_{CBO})	Increased	

The forward conduction (I_F) of diodes is decreased because of the increase in resistivity. More voltage is required to force a given current.

The breakdown voltage (B_V) or avalanche voltage is the voltage required to cause "ionization by collision", i.e., the electric field (applied voltage) supplies energy required to strip an electron from the valence shell of the atom. The released electron hits other electrons, knocking them out of their shells, and so on, to start a self-sustaining chain reaction leading to an almost infinite current.

Where gold is present, as explained before, there are fewer electrons. Also, many electrons lose energy as they move close to trap centers. This further limits the number of electrons getting to the conduction band.

The net result is that a stronger field (applied voltage) is required to start ionization by collision - hence higher breakdown voltage.

The basic explanation of why capacitance decreases with gold diffusion is analogous to an increase in the distance between the two plates of a capacitor. A more detailed explanation requires a discussion of spacecharge or depletion regions.

When a reverse bias is applied to a pn junction, the depletion region is widened on both sides of the junction as the voltage is increased. The depletion region is an area that is swept free for both minority and majority current carriers. (See Figure 4.). The widening is greater in the high-resistivity side because the number of carriers swept from each side of the junction must be equal. And lower resistivity means a higher concentration of carriers.

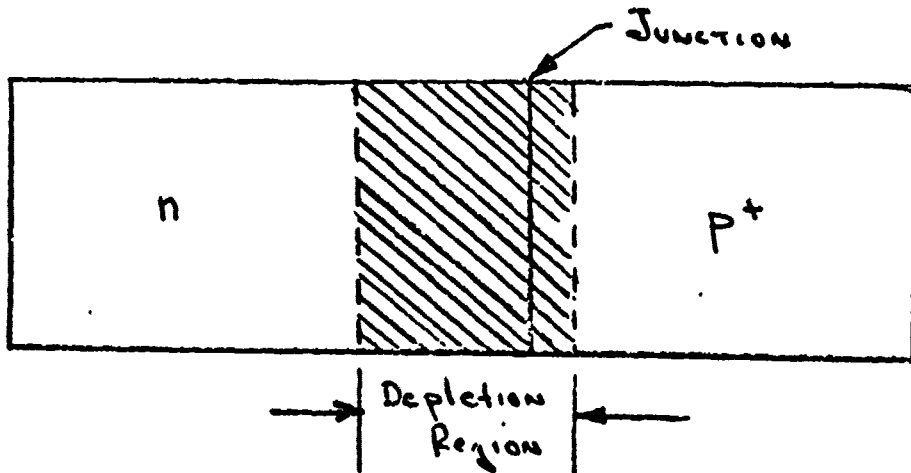

Figure 4: Model of pn Junction Showing Depletion Region

Previous discussion developed the fact that gold diffusion increases the effective resistivity. Therefore, for a given voltage, whether externally applied or the built-in voltage at zero applied volts, the depletion region will be wider after gold diffusion or radiation. The distance of widening of the region corresponds to d in the expression

$$C_0 \approx \frac{A}{d}$$

where C_0 = capacitance at zero bias

A = junction area

d = plate separation or depletion region width

As d increases, capacitance decreases, which is exactly what happens after either gold diffusion or radiation.

Diode reverse-recovery time (T_{RR}) is decreased by the presence of many more recombination-trap centers. (See Figure 5.) The conditions for a typical diode T_{RR} measurement are referred to as 10-10-1, which means that the diode is initially forward-biased at 10 ma. Then the bias is suddenly reversed with a pulse that drives the reverse current to 10 ma. The time it takes for the reverse-biased junction to recover to 1.0 ma is T_{RR} , 10-10-1.

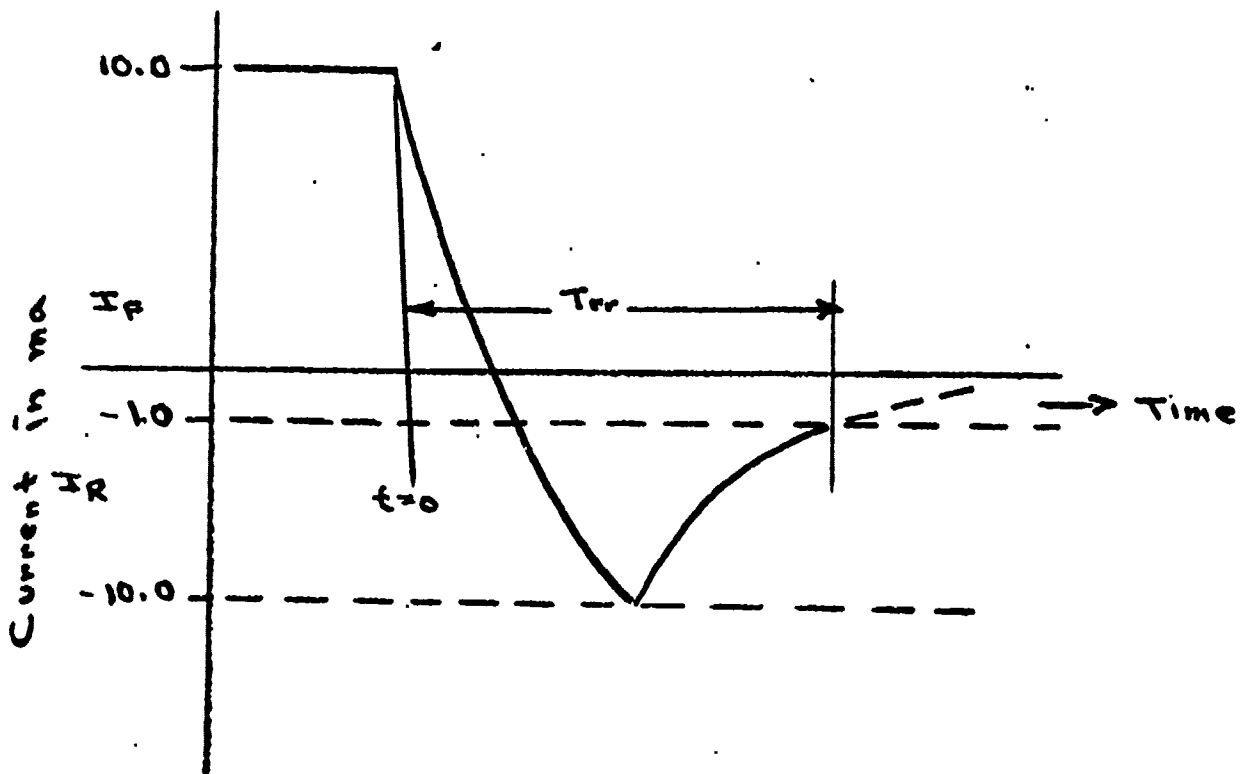

Figure 5: Measurement of Diode Reverse Recovery Time

In order to fully understand the T_{rr} change, it is necessary to consider conduction mechanisms. When the junction is forward-biased, majority carriers flow across the junction, i.e., holes from the p+ region into the n region and electrons from the n region into the p+ region. Because of the relatively high concentration of holes (p+) versus electrons (n), significantly more holes flow to the n region than electrons to the p+ region. (Note that when holes make the transition to the n side of the junction, they become minority carriers.) When the junction is suddenly reverse-biased, it is primarily the previously injected holes that must now, as minority carriers, race back across the junction or recombine. Since gold diffusion adds a significant number of recombination or trap centers, many of these minority carriers (both hole and electron) are attracted by the trap centers and recombined at a faster rate than if they had to cross the junction. The net result is that I_R recovers to 1 ma faster than if there were no gold present.

Transistor switching time is decreased for a similar reason.

An explanation of why reverse current increases after gold diffusion or radiation is complicated and difficult to explain briefly. However, the following explanation is offered. (See Figures 6 and 7.)

The recombination rate is significantly increased due to the presence of gold. For every hole-electron pair recombination, there is a corresponding pair generation, i.e., an electron is elevated to the conduction band.

True reverse current (in the absence of large surface currents) is a combination of drift or field current and recombination current. Drift current consists of already available current carriers flowing across the junction under the influence of an applied field. Recombination current refers to the additional current available due to the recombination-generation process. Since the recombination-generation rate is increased by the presence of gold, the reverse current is increased. I_{CBO} is increased for a similar reason in transistors.

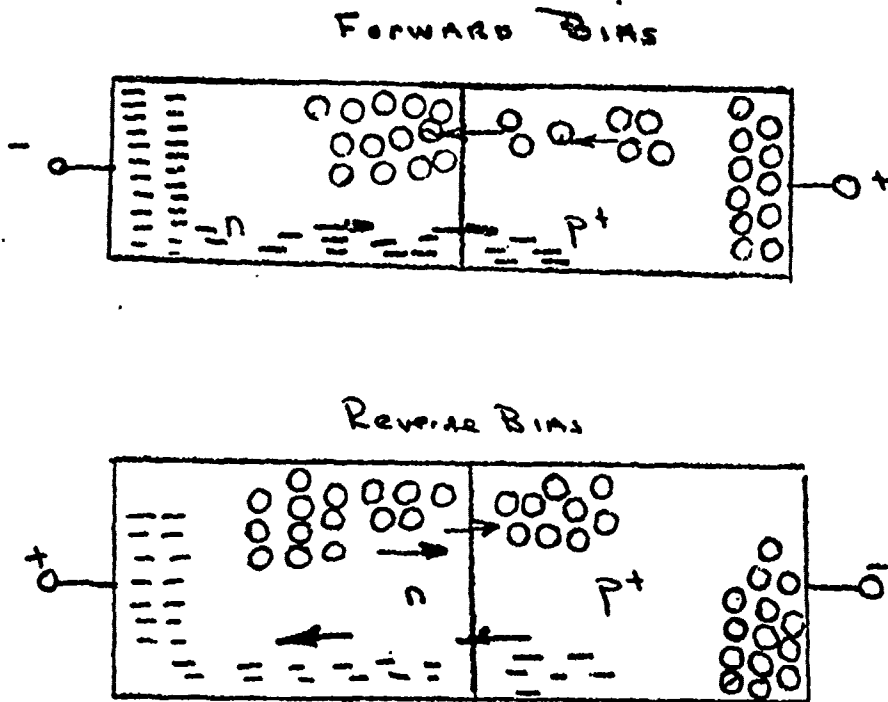

Figure 6: Models Showing Forward and Reverse Bias

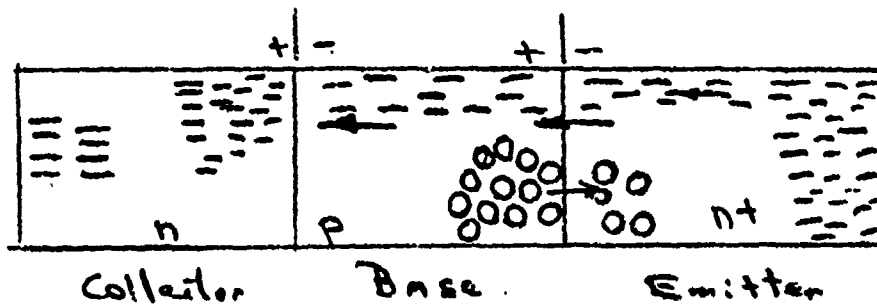

Figure 7: Model Showing Current Carriers in a Transistor

Transistor current gain decreases with gold diffusion or radiation. The reason also is associated with the increased density of recombination centers.

The basic physics of transistor gains is explained by the following principle: When a transistor is being used as an amplifier, the base-emitter junction is forward-biased (therefore, majority-carrier current flow) and the collector-base junction is reverse-biased (minority-carrier current flow).

Because the emitter is always more heavily doped than the base or collector, there is an excess number of electrons injected by the emitter into the base region. As soon as the electrons enter the p-type base region (assuming an npn transistor), they become minority carriers. They are, in turn, influenced to flow across the collector-base junction into the collector region inasmuch as that junction is reverse-biased (minority-carrier current flow).

The number of electrons from the emitter that reach the collector region is summarized by the term "emitter injection efficiency" and/or "transport efficiency." This efficiency figure is basically a function of the excess concentration of electrons in the emitter versus the holes in the base and how narrow the base region is. The thinner the base, the more chance there is for an injected electron to avoid recombination traps and reach the collector. The second item is concerned with the number of electrons that will recombine in the base region, therefore, never reach the collector region.

Gold diffusion and radiation damage add significant numbers of recombination centers and, therefore, increase the recombination rate in the base region.

$V_{CE(sat)}$ is the parameter that measures the total series resistance of the transistor. Any increased contact resistance or effective increase in bulk resistivity will increase $V_{CE(sat)}$. Inasmuch as gold diffusion or radiation increases the resistivity of the material, $V_{CE(sat)}$ is increased.

It should be restated at this point all of the preceding explanation was in terms of intermediate energy sites creating recombination centers. The model was one where gold atoms created intermediate energy sites. Radiation-caused vacancies and dislocations have a similar effect, so the explanation is valid for both situations.

An effect that may result from exposure of transistors to ionizing radiation is believed to result from the interaction of gas, surface contaminants, ionizing radiation, and electric fields at the junction surfaces. As one would expect, the magnitude of this effect varies widely among units of the same type made by the same manufacturer. Larger differences can be expected between transistor types and from manufacturer to manufacturer. In general, test data indicate that transistors in evacuated cases and planar transistors for low-current applications, there frequently occurs the previously discussed surface-linked-gain degradation, which sometimes starts at a radiation level 50 times lower than that at which bulk damage becomes effective. Unfortunately, this damage is difficult to predict and depends upon the surface processing used by the transistor manufacturer. It should also be noted that the extent of space radiation effects on transistors depend upon the transistor bias levels.

Radiation effects on transistors tested at Lockheed Missiles & Space Company were determined from changes of the following parameters: leakage currents (I_{CBO} , collector to base with emitter open, and I_{EBO} , emitter to base with collector open), saturation voltage ($V_{CE(sat)}$) and gain (h_{FE}). The data obtained from these tests for twenty transistors of one type is not identical. This independent behavior is very common in radiation effects measurements.

Radiation Resistance is dependent on transistor material and configuration. The following guidelines (based on transistor radiation tests) may be used for transistors which may be subjected to radiation.

1. Germanium devices are more resistant to radiation than are silicon devices.
2. Compound semiconductor, such as gallium arsenide, are more radiation resistant than elemental types, such as silicon or germanium.
3. Germanium NPN types are more resistant to radiation than PNP types.
4. Units encapsulated with a dry inert gas are superior to those incorporating silicon grease as the encapsulant.
5. Transistors with a high initial Beta will retain a higher beta following radiation than transistors with a low initial Beta. However units with higher beta will suffer a larger percentage degradation than will units with a lower initial beta.
6. The effect of induced photo current in transistors from radiation can be minimized by making the associated circuitry of low impedance.
7. When subjected to radiation the following transistor parameters vary as shown below.
 - a. Current gain (Beta) decreases
 - b. $V_{CE(sat)}$ increases
 - c. I_{CEO} (leakage current) increases
 - d. I_{EBO} (leakage current) increases with increasing radiation doses.

The curves in Figures 8, 9, 10, and 11 depict the manner in which various transistor parameters vary with exposure to increasing nuclear radiation doses.

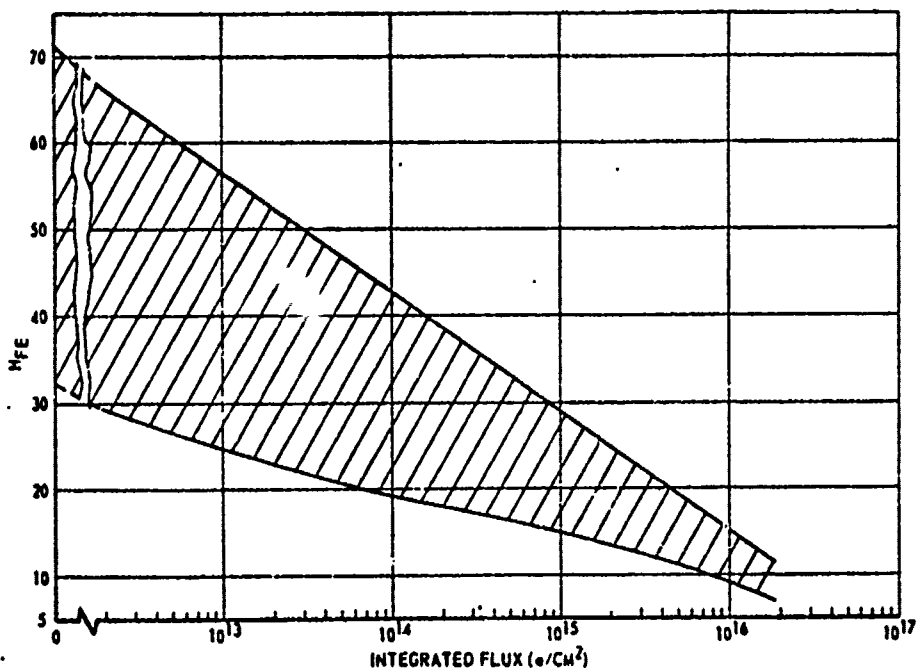

Fig. 8: Envelope of Current Gain (h_{FE}) Values for Ten 2N1613 Transistors Irradiated with 1-Mev Electrons

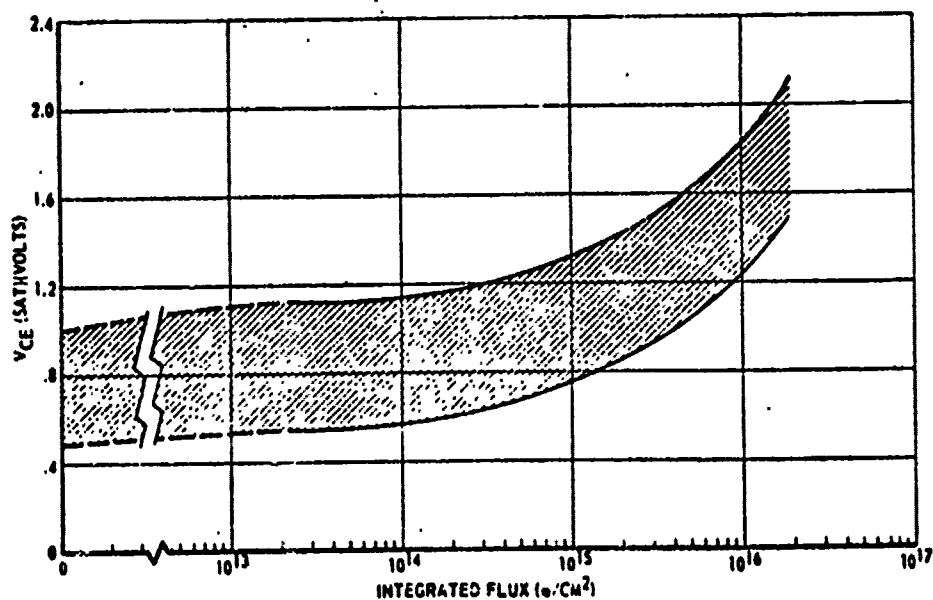

Fig. 9: Envelope of Saturation Voltage $V_{CE(Sat)}$ Values for Ten 2N1613 Transistors Irradiated with 1-Mev Electrons

Note: 2N1613 Transistors: NPN Double Diffused Planar Silicon Transistors

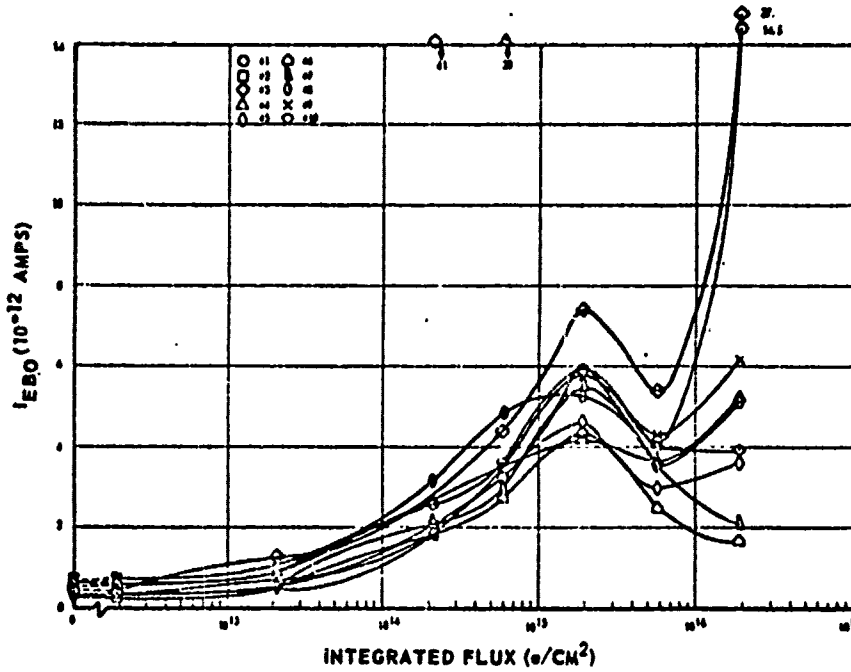

Fig. 10: Leakage Current (I_{EBO}) vs Integrated 1-Mev Electron Flux for Ten 2N1613 Transistors

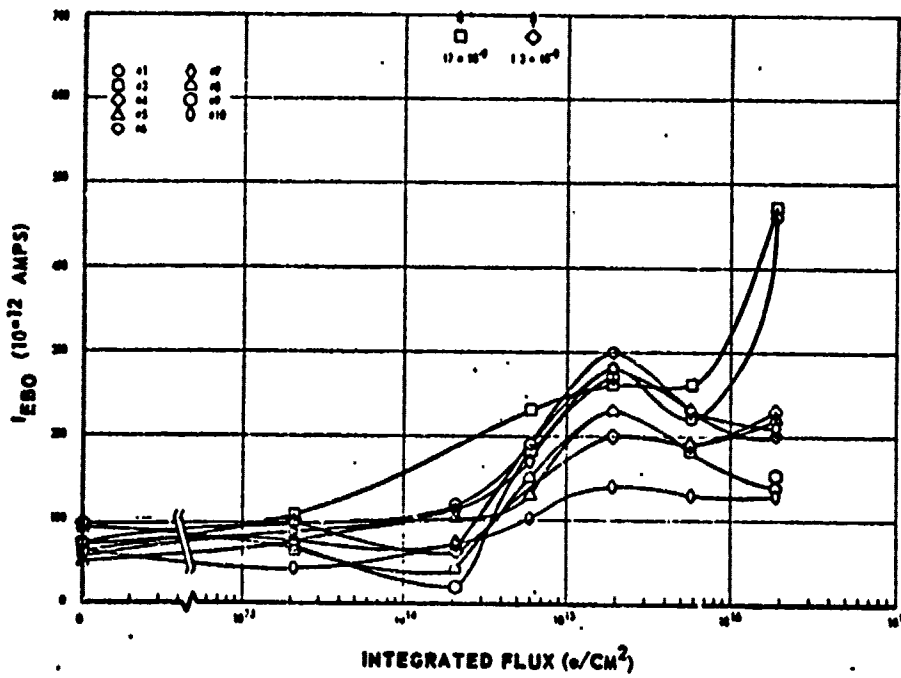

Fig. 11: Leakage Current (I_{EBO}) vs Integrated 1-Mev Electron Flux for Nine 2N1613 Transistors

Design of Radiation-Tolerant Transistor. Fairchild's radiation-tolerance transistor (FT-0040) is an npn, epitaxial, high ft, small geometry design. The important feature of the design is the extremely thin base (only 0.2 micron). This minimizes the effect of increased recombination in the base region. If the base recombination rate were too high, it would be impossible to have transistor current gain after radiation.

High concentrations of impurities in all regions minimize changes in electrical characteristics caused by radiation. Design Guidelines for both transistors and diodes are presented below.

Certain semiconductor device parameters should be kept as small as possible. Power rating, P_o , as a reflection of cross-section, should be minimized and h_{fe} should not be overrated. Applied voltages should be kept small to reduce collector depletion width. Bias levels should be kept small, if possible.

Base-emitter circuit impedance should be kept low, and collector-emitter impedance should be kept high.

The highest possible alpha cutoff is desirable because it is associated with the smallest base minority-carrier lifetime. Shorter lifetime increases the recombination rate of excess stored charge, and so reduces both the peak value and duration of the output pulse.

If a drift field is present in the base region of a transistor, the device should also be of a type having a low base lifetime, which is usually the case with diffused-base transistors.

The contribution of the collector region to primary current, I_{pp} , can be reduced by choosing a device having a low collector lifetime, which is equivalent to a short diffusion length. On this basis, alloy triple-diffused or epitaxial layer is less than a diffusion length.

In the transient radiation environment, pn-junction field-effect devices do not perform as well as the best high-frequency bipolar transistors. However, tests on thin-film insulated-gate field-effect transistors show them to be unaffected by transient dose rates of 10^8 roentgens/sec. They are expected to be superior to other transistors in dose-type environments as well.

Radiation Resistant Transistors: The electrical parameter best correlated to gain degradation is the gain bandwidth product, f_T . Since transistors are only required to meet certain electrical specifications, transistors of one type will vary with respect to degradation as a result of radiation. This situation occurs since different types of construction and processes may be used by each manufacturer that will meet the required electrical specifications. Steps to consider in selecting radiation-resistant devices and appropriate operating conditions are

- (1) Give preference to silicon passivated devices, since they appear to be less sensitive to ionizing radiation surface effects.
- (2) Using published information, select devices with high cut-off frequencies.
- (3) Select transistors with small breakdown voltages.
- (4) Give preference to epitaxial construction if available for the particular application.
- (5) Operate devices at high temperature and high injection consistent with circuit needs to take maximum advantage of annealing.
- (6) Provide ample base drive for transistors designed to operate in saturation.

Field-Effect Transistors: The general effects of nuclear radiation on field-effect transistors can be summarized as follows:

- (1) Changes are noted in the threshold voltage, V_T , due to the formation of surface charge and/or surface channels at or near the Si-SiO₂ interface. These changes in threshold voltage affect most of the field-effect-transistor parameters.
- (2) Increases in leakage current are observed due to carrier generation in the depletion region and surface contaminants near the junction edge.
- (3) Changes in channel resistivity and carrier mobility are observed due to the change in the effective impurity concentration.

Damage in MOS field-effect transistors is due primarily to ionizing radiation. For this reason damage is reported in terms of dose or exposure rather than fluence.

Switching and General-Purpose Diodes. As described earlier, the primary bulk effect of space radiation on semiconductor devices is the degradation of the minority-carrier lifetime caused by the creation of lattice defects that act as recombination centers. Because solid-state-diode current varies as the inverse of the square root of the minority-carrier lifetime and exponentially with the base voltage, maintenance of a constant forward current generally means that the diode forward voltage will increase with increasing radiation levels. The changes in forward characteristics will usually occur at lower levels for junctions with higher base-material resistivities. In devices that are conductivity modulated, the degradation of minority-carrier lifetime ultimately causes the collapse of the conductivity-modulation mechanism, resulting in an increase in dynamic forward resistance.

The reverse characteristics of semiconductor diodes also show important permanent changes due to radiation. The reverse leakage current, which usually increases with radiation, can be approximated by three separate components, i.e., the reverse saturation current, the carrier-generation current, and the surface-leakage current. The reverse saturation current will increase as the inverse of the square root of the minority-carrier lifetime, while the carrier-generation is inversely proportional to minority-carrier lifetime. The third component, the surface leakage, depends on the surface condition, the presence of surface charge, and the surface recombination. This component is generally incalculable. In many silicon diodes, this surface component of current will dominate over the other two components of current combined. However, the surface-leakage currents in diodes with passivated surfaces are generally reduced to such a magnitude that the bulk currents predominate. For silicon, the carrier-generation current is larger than the diffusion (saturation) current, while the germanium, the diffusion current will be the larger of the two components.

The breakdown voltage under reverse-biased conditions also shows an increase with increasing radiation levels. An abrupt p-n junction with high breakdown voltage will be more sensitive to radiation than one with a low breakdown voltage.

Capacitance, although frequently assumed to change with conductivity of the semiconductor material, does not necessarily change with radiation. The diffusion capacity, a portion of the total capacity, is dependent on minority-carrier lifetime and will change with radiation. However, no conclusive experiments have indicated a trend in space-charge capacity.

Switching time and storage time are directly dependent on minority-carrier lifetime. These parameters will decrease with radiation.

Since the radiation-induced degradation of minority-carrier lifetime is the primary cause of bulk damage to diodes, as it is with transistors, it is logical to expect transistors and diodes to be damaged by comparable radiation levels.

However, this consideration is misleading, since the significance of changes in forward voltage, reverse leakage, switching and storage time, and so on, in diodes is usually not comparable to that of gain changes in transistors. In other words, a diode whose forward voltage has increased by 100 percent may still be quite suitable for use in its application, and indeed may still be within the limits of the manufacturer's specification, whereas a transistor whose gain has decreased by 100 percent would be a catastrophic failure.

On the basis of reactor-irradiation data (mixed neutron and gamma flux), and considering the utilization of the device in circuitry, it is generally believed that semiconductor diodes are about 2 orders of magnitude less sensitive to radiation than are transistors.

It is important to note that for diodes as well as transistors, the effects of radiation may vary somewhat with electrical-bias conditions. Where the space application depends upon use of diodes in low-current circuitry (e.g., micropower circuitry), the significance of space-radiation effects may be greater than would be the case in higher current applications.

For switching diodes, space radiation exposure may be beneficial from the viewpoint that the switching speed will increase as the minority-carrier lifetime decreases. Electron irradiation is sometimes employed as a processing step to increase diode switching speed. Diode switching times of 10 μ sec have been routinely reduced to 10 η sec by electron irradiation.

Zener and Voltage-Reference Diodes: As discussed previously, increases in forward voltage and breakdown voltage may be expected as a result of diode irradiation. Since the desired performance of Zener and voltage-reference diodes is the maintenance of a constant breakdown voltage or forward voltage, the possibility of a significant change in these parameters caused by radiation is of concern.

A number of voltage-reference and Zener diodes have been irradiated in a Co^{60} gamma-ray source to an exposure of about 1×10^9 ergs g^{-1} (C). From two to five samples of each of nine diode types were tested. The percentage change in the average diode voltage caused by irradiation was less than 1 percent for all diode types. However, individual specimens of a high-voltage Zener diode were observed to change by as much as 3.6 percent with both increases and decreases in voltage occurring. This variability in radiation effect may cause problems in critical applications utilizing high-voltage diodes.

Tunnel (Esaki) Diodes: Studies of the effects of nuclear radiation on tunnel-diode performance have indicated that they can withstand a much higher neutron level than can most of the other semiconductor devices.

Semiconductor Diodes. The following guidelines may be used for diodes which may be subjected to radiation. These guidelines are based on tests conducted at Lockheed Missiles and Space Company where the forward voltage drop (V_{FD}) and reverse current (I_R) were measured on diodes during radiation tests.

1. Germanium diodes and rectifiers are less radiation sensitive than are comparable silicon devices.
2. Diffused junction devices are less sensitive than are alloyed devices.
3. There are major radiation damage differences in similar diodes made by different manufacturing techniques.
4. Germanium diodes should be protected from self-destruction resulting from excessive power dissipation from radiation degraded reverse characteristics.

5. In germanium diodes, point contact and p-n junction, forward current decreases and reverse current increases with increasing radiation dose.
6. In silicon p-n junction diodes, the forward current and reverse current increases with increasing radiation dosage.
7. Esaki (tunnel) diodes of gallium arsenide, germanium and silicon have been found to remain constant in peak current, whereas the valley current increases with increasing radiation dose.

The curves in Figures 12, 13, and 14 depict the manner in which various diode parameters vary with exposure to increasing nuclear radiation doses.

Resistivity and Radiation Tolerance. Diodes made from low-resistivity material exhibit less parameter change when irradiated than do diodes made from high-resistivity material. And, of course, the heavier the doping, the lower the resistivity. Impurity doping, gold diffusion and irradiation all tend to have the same effect on minority-carrier lifetime. Therefore, a diode that is heavily doped or gold diffused will start out with characteristics similar to an irradiated diode. The effects of radiation will thus be masked.

Pin designs with their highly resistive intrinsic regions show the most noticeable effect after radiation. They generally should be avoided in radiation environments unless their use is dictated by other key parameter requirements.

The heavy gold diffusion philosophy is reflected in the design of Fairchild PICO second switching diodes. (Epitaxial wafer material with high impurity concentration also is a factor in the radiation tolerance of these diodes.) The PICO second FDR-700 shows no change in parameters after an integrated dose of 10^{15} nvt. Both the PICO second FDR-700 and NANO second FDR-600 diodes are suitable for use in radiation-resistant designs.

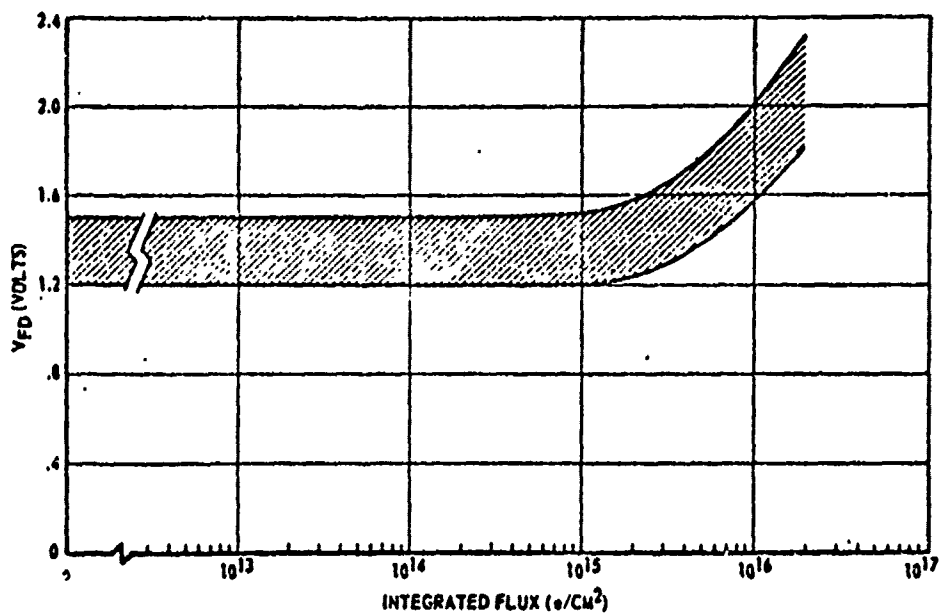

Fig. 12: Envelope of Forward Voltage Drop (V_{FD}) Values for Ten 1N645 Diodes Irradiated with 1-Mev Electrons

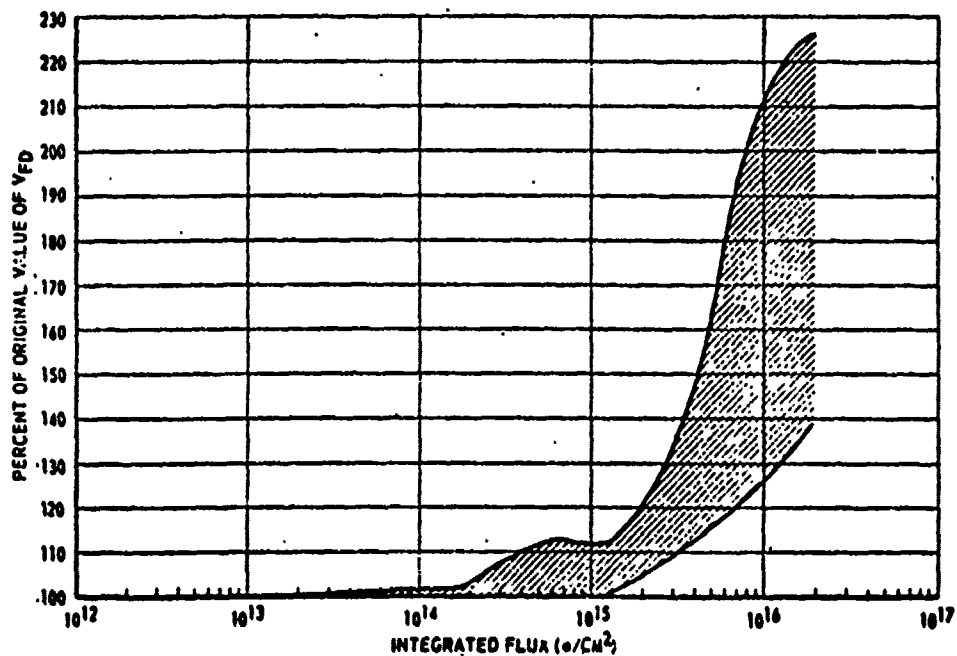

Fig. 13: Envelope Showing Percent of Original Value of Forward Voltage Drop (V_{FD}), Ten 1N645 Diodes Irradiated with 1-Mev Electrons

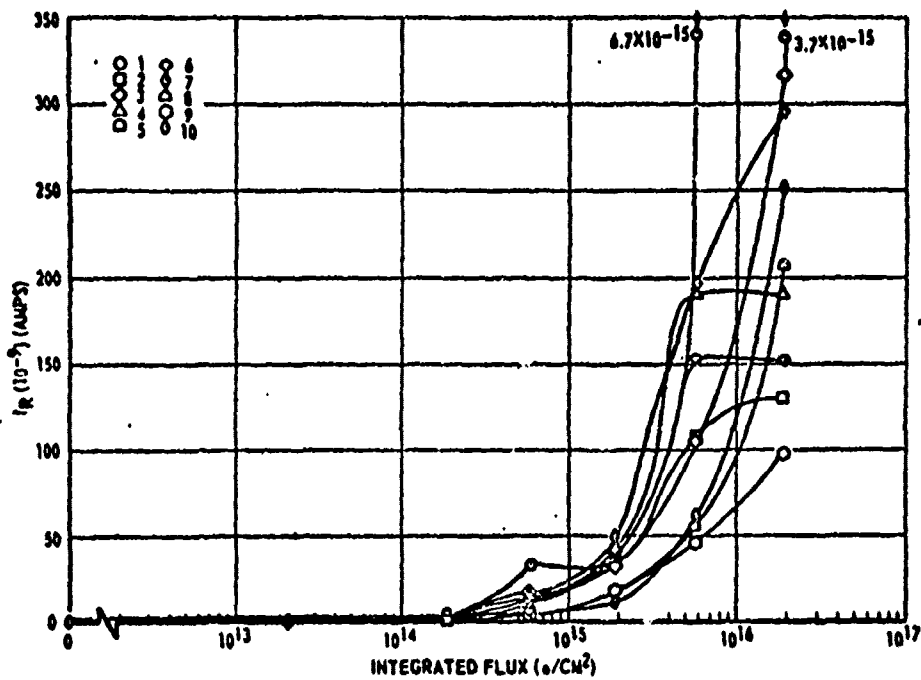

Fig. 14: Reverse Current (I_R) vs Integrated 1-Mev Electron Flux for Ten 1N645 Diodes

Silicon-Controlled Devices. There are three basic types of silicon pnpn devices: the silicon-controlled rectifier SCR; the silicon-controlled switch, SCS, and the Schockley diode. All of these devices may be considered to consist of overlapping npn and pnp transistors, the primary difference being the external accessibility of the various layers; that is, the Schockley four layer diode provides external access to only the outer p- and n-layers, the SCR has leads to all but the central n-region, and the SCS has leads to all four regions. The "two transistors" of the pnpn structure operate in a positive-feedback configuration, and the current-transfer ratios of the two sections add together for the composite device. Radiation-induced defects reduce the transfer ratios for both "transistors" so that the required gate current, holding current, and breakover voltage should increase with radiation at fluences comparable to the bulk-damage fluence levels in silicon transistors. When the transfer ratios (β) becomes so low that the product of these ratios for the two sections is less than 1

$(\beta_{\text{nnpn}}) + (\beta_{\text{pnp}}) < 1$, the pnpn switches off, and as long as this condition persists no amount of gate current applied to the SCR or SCS, or no increase in voltage applied to the Schockley diode can cause the device to conduct. Thus, it is expected that the pnpn device will be at least as sensitive to radiation as are silicon transistors.

Theoretical considerations of the mechanisms of pnpn device operation also indicate that excessive leakage currents will cause premature triggering of the devices. Hence, ionization currents and/or increases in surface- and bulk-leakage currents induced by radiation may cause the device to conduct continuously. This effect will depend upon the bias level applied in the application as well as the radiation flux.

Experience with silicon-controlled rectifiers in nuclear-radiation environments confirm the above theoretical predictions.

It should be noted that, since PNP devices are used in medium to high power applications, they cannot be compared to high-frequency transistors in radiation resistance. Typically, failure thresholds for PNP devices range between 10^{12} and 5×10^{14} ($E > 0.01$ MeV). Narrow base PNP devices appear to be superior to bipolar transistors as high power switches in a radiation environment. The conclusions are that these devices are capable of switching more than a kilowatt of power (product of maximum blocking voltage and maximum "on" current) at fluences on the order of 10^{15} n/cm² which is an order of magnitude superior to present bipolar transistors.

Silicon controlled rectifiers and pnp switches are highly sensitive to radiation, but can be used if voltage is not applied during transients, as is true of other semiconductor devices. SCR's and pnp switches can be operated in their normal ON position even though permanently damaged, if proper component-placement and synthesis techniques are used.

Integrated Circuits. Integrated circuits include many circuit types differing in construction materials and methods. The three construction types are the monolithic semiconductor, the thin-film, and the hybrid integrated circuit. The scope of this section will be limited to monolithic and thin-film circuits. The discussion of the monolithic circuits junction-isolated and dielectrically isolated circuits containing bipolar transistors and MOS circuits containing field effect transistors.

On a qualitative basis, the primary electrical effects introduced in integrated circuits by transient radiation are not unlike the effects that have been observed in conventional solid-state circuitry. The magnitude, duration, and electrical consequences of these effects, however, do not follow directly from conventional-circuit experience.

It has been observed that the effects of radiation on an integrated circuit are more closely related to its geometrical and physical characteristics than to its electrical function or circuit configuration. The proximity of circuit elements within the device, and in some cases its integral structure, make

possible several modes of secondary interaction. This is especially important in the case of monolithic semiconductor integrated circuits using PN-junction isolation. Minority-charge carriers created by ionization are freely transported across the junctions and may induce further secondary effects similar to those discussed for the transistor.

Transient radiation may cause both transient and permanent effects. The transient effects result from nonequilibrium free-charge conditions introduced through ionization phenomena, resulting primarily from the electromagnetic radiation. The effects of neutron ionization also have been observed. The permanent effects are attributed to physical-property changes of the irradiated materials caused by energetic particles (neutrons and electrons). It should be noted that the transient and permanent effects are defined by the primary-induced effect of the radiation. For example, the short-term currents resulting from ionization may trigger a digital state change or thermally damage a device. This phenomenon is treated as a transient effect because the permanent consequences result from circuit action or heating damage rather than from a direct radiation-induced material-property change.

Transient Effects: Any integrated circuit represents a complex material system with heterogeneous elements in close proximity. The transient effects of radiation in integrated circuits have been found to depend critically on the specific structural characteristics. Since the structural characteristics of both semiconductor and thin-film integrated circuits are highly variable, devices with similar electrical characteristics may have significant differences in radiation response. It is thus not accurate to group the radiation response of integrated circuit according to the nominal electrical design, logic or amplifying function, or other electrical characteristics.

The transient effects observed in integrated circuits are due to the creation of excess-charge carriers that cause photocurrents and voltage changes. As was developed for transistors, the motion of excess-carriers is governed by the response of carriers to electric fields and concentration gradients. The charge carriers will cause currents to occur until they are swept out by external fields and electron-hole recombination.

The analysis of radiation response is most profitably approached through consideration of effects that may occur in and between elements of the integrated circuit. Viewed from this standpoint, the transient effects of radiation in integrated electronic devices result from the combined action of several possible phenomena. These phenomena, discussed in Section E of the handbook, include ionization currents in gaseous- and solid-phase materials, replacement currents, and any resultant circuit action. The actual work revolves around the selection of the predominant phenomena for a particular device type and the determination of resultant effects according to the device's physical and geometrical characteristics.

The three types of monolithic semiconductor integrated circuits discussed in this section are junction-isolated, dielectrically isolated, and MOS integrated circuits. In the junction-isolated type, circuit components are defined within a doped single crystalline substrate by regions of alternate doping, and are electrically isolated by reverse-biased PN junction boundaries. The doped regions are formed by the geometrically controlled diffusion of appropriate impurities into the substrate. One or more uniformly doped epitaxial layers may be grown upon the substrate prior to diffusion (planar epitaxial). The active elements are bipolar transistors.

The dielectrically isolated integrated-circuit type is distinguished by the use of a dielectric (silicon dioxide or ceramic) instead of a PN-junction isolation between critical components in the circuits. A single component or a small number of components are formed within individual oxide-covered single-crystalline islands that are imbedded in a polycrystalline substrate. Bipolar transistors are also the active elements for these devices.

The MOS integrated circuit employs aggregates of unipolar (field-effect) transistors of the metal-oxide-silicon construction. Since this type of transistor may be used as a bias-dependent resistor, complete designs are usually constructed without use of other circuit elements.

Quite generally, the transient effects in any integrated electronic device are a consequence of a sequence of events that may be described as follows:

- (1) The radiation interacts with the circuit material and surrounding encapsulant to introduce charge carriers and establish a nonequilibrium charge distribution.
- (2) Acting under nonequilibrium electric fields and concentration gradients, mobile carriers flow in the direction that restores equilibrium and thereby produce primary electrical currents. These electrical currents may be semiconductor-junction photocurrents, replacement currents, dielectric-leakage currents, gas-ionization currents, etc.
- (3) The nonequilibrium charge distribution and the primary electrical currents may interact with the electrical circuit to produce secondary effects, e.g., secondary photocurrents. Under certain circumstances the secondary effects may be sufficiently regenerative as to be self-sustaining, and a new stable-circuit state will result. In addition, localized electrical stresses may introduce permanent damage.

- (4) The cumulative effects of the radiation-induced currents and circuit action on these currents are voltage and impedance changes of variable duration at the integrated-circuit terminals.

In junction-isolated circuits, the predominant primary effect is PN-junction photocurrents resulting from ionization in the semiconductor material. Important secondary effects to be considered are secondary photocurrents produced by transistor action in any three adjacent doped regions, large substrate currents, and "latch-up".

In dielectrically isolated circuits, the same effects should be considered, except that the current-flow paths are more restricted.

In MOS integrated circuits, important primary effects are drain-substrate PN-junction photocurrents, replacement currents resulting from charge scattered from device lead wires and the case, and ionization currents through the surrounding encapsulant. The predominant secondary effect is a secondary drain current resulting from the combined gate current.

Tests for transient effects in microelectronic components have shown that bulk integrated circuits are more resistant to radiation than conventional transistor circuits. Developmental low-frequency thick-film integrated circuits appear to be an order-of-magnitude better than bulk monolithic circuits. This situation was expected by radiation specialists, aware that semiconductor susceptibility to transient radiation decreases with base width and with increasing gain-band-width product.

The thin-film tests also support evidence that the isolation substrate of semiconductor devices plays an important role in determining susceptibility to transient radiation.

In tests of several types of monolithic circuits, conducted for the Navy at Hughes Aircraft Co., the most resistant circuit was a digital gate having only one high-frequency transistor and at least one input diode always in a forward-biased condition when the gate was off.

Forward-biased diodes are not seriously affected by transient radiation. But transient gamma dose rates as low as 10^6 roentgens/sec clearly affect many monolithic silicon circuits.

In another test at Hughes, a planar epitaxial micrologic gate showed five times more resistance to a gamma dose than the same gate in a simple planar version.

Hughes has made a variety of integrated-circuit transistors and complete integrated circuits. All of the circuits were tested in the OFF position because of previous evidence that transistors and diodes are relatively resistant to transient pulses when on, unless they are operating in the low-current region of their range. However, the digital gate mentioned above as most resistant performed best in an ON position. Hughes investigators explain this by analyzing the electrical equivalent of the gate which was a Signetics SE102K.

The gate's input diodes are actually transistors having a common collector region and one coupling diode that serves as the emitter base junction of a transistor. The collectors of the transistors have substrate isolation diodes that are biased to ground. Because these isolation diodes are connected to the anodes of the input diodes they can conduct a large reverse current during transient radiation pulses. These pulses divert current from the base of an ON transistor and tend to turn it OFF.

Although many of the variables that determine radiation resistance in semiconductor integrated circuits are not well defined, a number of guidelines indicated below are generally accepted. Although the guidelines refer to process technology, they are useful as criteria for selection of devices.

(1) All Types

- Aluminum interconnection preferred to gold interconnection
- Minimize element geometries
- Use encapsulant with high ionization energy.

(2) Junction-Isolated and Dielectrically Isolated

- Minimize impedance at bases of transistors
- Minimize lifetime in base and collector regions (highest transistor cutoff frequency with gold doping)
- Optimize compensation of induced currents.

(3) Junction-Isolated

- Minimize chip area and the area of transistor isolation junctions
- Make the collector width as small as possible. Use buried-layer epitaxial construction to prevent transistor action through substrate and to minimize collector ohmic drops
- Make terminal connections to substrate at several points to minimize substrate ohmic drops.

(4) MOS

- Do not employ diodes at gate inputs.

In addition to the above general guidelines, other hardening criteria may be developed for specific integrated circuits and integrated-circuit types. For example, the following four improvements have been found to greatly decrease the susceptibility of junction-isolated DTL gate circuits.

- (1) Use circuits that connect the cathode of the resistor-isolation diode to the most positive voltage in the circuit. This procedure will, however, increase power supply surge currents.
- (2) Use DTL circuits that have output-load (pull-up) resistors.
- (3) Use the emitter-base diodes of a multiple-emitter transistor to reduce the isolation-diode area associated with the input diodes.
- (4) Use the highest possible supply voltage consistent with power requirements.

In many cases, a common-sense consideration of the physical mechanisms of the transient effects and the particular integrated-circuit construction can point to obvious shortcomings and generate specific hardening improvements.

Permanent Effects: The proximity and intercoupling of elements do not assume importance with respect to the permanent effects of displacement radiation. Monolithic semiconductor integrated circuits may be treated as conventional circuits of small dimensions with silicon elements. The primary determining factor of the tolerance of the circuits to radiation-induced permanent effects is the degradation of the active elements with accumulated neutron fluence.

The radiation resistance of the circuits is determined by the stability of the gain of the transistor elements with respect to neutron fluence and the tolerance of the circuit design with respect to gain degradation. Although no class of integrated circuits has been shown to be inherently superior to another, those circuits employing faster transistors usually can withstand a greater neutron fluence. Epitaxial transistors usually, but not exclusively, represent the faster transistor types.

The effects of radiation-induced component changes on integrated-circuit parameters will, of course, depend on the specific configuration involved. However, with respect to digital circuitry, the following parameter changes may be delineated because of their dependence on features common to the circuits:

- Saturation Voltage - The saturation voltage of transistors increases with neutron fluence, even though sufficient base drive is supplied to maintain the transistor in saturation. These changes in saturation resistance are usually negligible at threshold fluences applicable for maximum fan-out. However, at low fan-outs (1 and 2), the devices may fail at fluences lower than the threshold fluence due to changes in saturation resistance.
- Input Threshold Voltage - This parameter will normally increase with exposure because of increases in the transistor forward base-emitter voltage and decreases in transistor gain.
- Switching Time - The output transistor determines the switching characteristics of the circuit. The switching time is composed of the delay time, the rise time, the storage time, and the fall time. The delay time and the fall time are relatively independent of radiation exposure. The rise time increases with radiation and the storage time decreases with radiation exposure. At the threshold fluence, decreases in the storage time are usually greater than increases in rise time. Thus a net decrease in switching time is commonly observed.

Hybrid Integrated Circuits: Conventional hybrid circuit and monolithic circuit construction techniques are frequently marginal in certain aspects of wire bonding, die attach, etc. Tests have shown that 2 cal/cm^2 , in some instances, caused transistor lead bonds to break. Subsequent Febetron experiments with semiconductor components, including integrated circuits in a variety of packages, have confirmed that a small but significant proportion will fail upon irradiation. The most common failure mode is an open circuit due to broken wire bonds. Both thermocompression and ultrasonic wire bonds are susceptible to failure. Sometimes the failure occurs at the transistor post or integrated circuit lead frame and sometimes it happens at a point where a wire is bonded to the metallized pad on a silicon chip. The failure will be characterized by a break in the wire in some cases while in other instances the bond simply lifts off the surface to which the wire had been affixed. The stresses imposed by the dose deposition cause a rupture to occur wherever a weakness exists in the bonds.

Similarly, faulty die attach techniques can cause semiconductor components to suffer die fracture or die lift-off when parts are irradiated in a Febetron machine. Usually the trouble can be traced to a void under the silicon die. All the conventional die attach methods are highly dependent upon the skill of the operator so human fallibility guarantees the incidence of some weak parts.

Still another potentially weak point in conventionally packaged microelectronic parts is the hermetic seal. Flat packs, in particular, seem susceptible to problems of this kind. The added fact of high packaging costs makes attractive the idea of eliminating hermetic packages for microelectronic components.

The use of Resistor-Transistor Logic fabricated with junction FETs or radiation resistant bipolar transistors should result in the hardest digital system presently available insofar as the effects of radiation on the semiconductor material itself is concerned. There remains the problem of overcoming the mechanical weaknesses so prevalent in currently produced microelectronics that can be the source of failure under the stresses imposed by high dose deposition rates in a nuclear environment.

Tests and analyses of radiation resistant hybrid circuits at Lockheed Missiles & Space Company have resulted in the following conclusions:

- Digital logic elements formed with Resistor-Transistor-Logic (RTL) should be more radiation resistant than those made with other common logic schemes.
- NOR logic elements can be made in RTL hybrid circuit form with a minimum number of active components. These components can be specially selected for their radiation resistant characteristics.
- RTL hybrids can be built with discrete field effect transistors that are inherently more radiation resistant than bipolar or MOS transistors.
- Wire bonds, die attach, and hermetic packages can be eliminated from hybrid circuits by using beam lead transistors and ultrasonic bonding.
- This type of hybrid assembly should be amenable to automation with consequent cost savings.
- These hybrid circuit concepts are not restricted to any particular metallization scheme for substrates and transistor dice. The circuits might most easily be made with thick film resistors and

gold metallization on the substrates and gold beam leads on the transistor dice. Perhaps even more attractive, conceptually, would be a low Z construction based on aluminum beam leads for the transistor dice and aluminum metallization and thin film resistors on the substrates.

Radiation Hardening Techniques for Integrated Circuits: Producers of hardened military equipment use one or more digital and analog methods to analyze their circuits for radiation resistance. (See Fig. 15.). These are:

- The basic method, which is to make calculations based on physical phenomena in insulators, conductors and semiconductors to predict how components and circuits will behave. In this method the effects of Compton, photo and pair-production electrons are usually calculated in terms of their secondary currents, polarization effects and conductivity in the materials and structures involved.
- The component approach, which allows a large class of circuits to be analyzed on the basis of how their component types react in radiation environments.
- The circuit analog method, in which circuit behavior is predicted by using circuit engineering information in conjunction with data on charge-redistribution effects on components.
- The direct circuit method, in which the analysis is made by extending the charge redistribution philosophy to include actual leakage resistance and charge generators in the representation of real-time circuits. The physical circuit is represented by matrix switching of conductances and by generation of frequency-compensated input current pulses.
- The subsystem method, which is an advanced technique involving simplified transfer functions or individual circuits. The functions are recalculated for different initial conditions until a specific performance in the expected environment becomes clear.

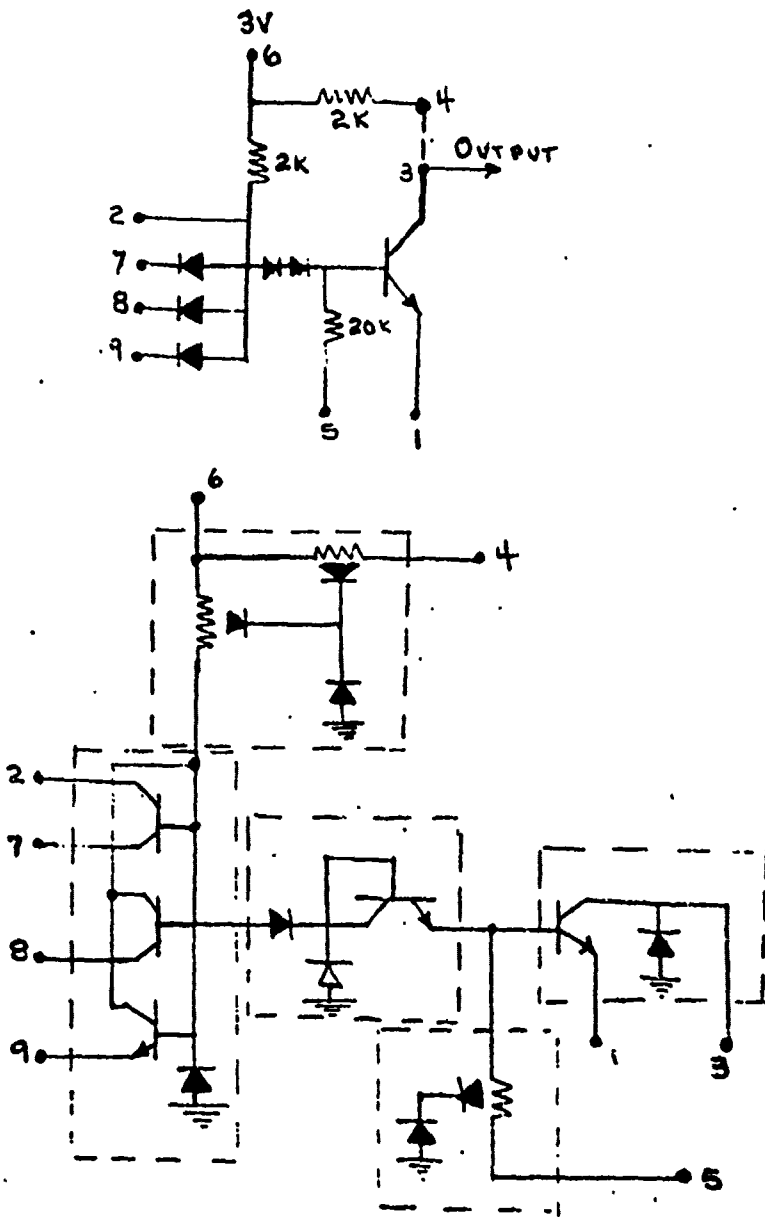

Note: Unit showed most radiation resistance in its OFF rather than ON state in tests.

Fig. 15 Signetics SE102K Digital Integrated Gate (Functional Circuit, Left; Actual Circuit, Right)

Several organizations, including Hughes Aircraft Co., Fullerton, Calif., International Business Machines Corp., Owego, N.Y., and Boeing Aircraft Co., Seattle, Wash., have developed sophisticated versions of these analytical methods. Hughes uses analog methods; the most advanced techniques used at IBM and Boeing are digital.

Passive Components

Passive components such as resistors, capacitors, coils, and insulators are orders of magnitude less sensitive to radiation than are most semiconductor components. Because of the concentration of effort in the semiconductor-component radiation-effects area, relatively few experimental studies have been conducted for passive components in proton, electron, or neutron environments. However, the data available generally confirm the lower radiation sensitivity of passive components relative to that of semiconductor components. The available data concerning the response of passive electronic components to proton, electron, and neutron radiation are summarized in the following paragraphs:

Resistors. Radiation effects on resistors are generally small in comparison with those for semiconductor devices and capacitors. The effects on other devices over-shadow the effects on resistors to the extent that resistor effects are often justifiably neglected. The primary transient effect on resistors, especially those of greater than approximately 1-megohm resistance, is that of a shunt leakage due to ionization. Resistors with air cores show larger effects than those of solid construction. Altering the environment of the resistor by such means as potting in paraffin or silicone rubber greatly improves resistor performance under irradiation. Although the effects are generally manifested as an apparent reduction in resistance, wirewound types have shown increases in resistance.

The transient effects are generally attributed to gamma rays that interact with materials to produce electrons, primarily by the Compton process; however, energetic neutrons can also produce significant ionization. The permanent effects are generally caused by the displacement of atoms by neutrons, causing a change in the resistivity of the material. Transient effects include (1) a change in the effective resistance due to radiation-induced leakage in the insulating material and the surrounding medium, (2) induced current that is the result of the difference between the emission and absorption of secondary electrons by the resistor materials, and (3) change in the conductivity in the bulk material of the resistor. There is no substantial evidence, however, that the third listed effect is a first-order transient effect.

Carbon-composition and carbon-film resistors are recognized as the most sensitive to nuclear radiation of the various resistor types. This sensitivity to radiation damage has been attributed to degradation of organic materials used in the construction of these resistor types. Because of the weaknesses observed in nuclear irradiation of carbon-composition and carbon-film resistors, studies have been conducted to determine the effects of proton irradiation. Allen-Bradley carbon-composition resistors with nominal resistance values of 470 and 100,000 ohms were irradiated with 22-Mev protons to fluences ranging from 1.15 to 2.31×10^{13} p cm⁻². The results showed that no resistance changes of a permanent nature had occurred. Carbon-film resistors manufactured by Texas Instruments, Inc., and having the same nominal resistance values were irradiated in the same experiment. The results again indicated that the irradiation did not cause permanent damage. No measurements were made during irradiation, so that information concerning possible temporary effects is not available.

Radiation studies at Lockheed Missiles & Space Co. and the Battelle Memorial Institute have been conducted on a variety of resistor configurations, including carbon composition, carbon film, metal oxide film, pure metal film, and wirewound. Primarily, the effects of time integrated, fast neutron flux dosages have been investigated. The results of these tests have not only indicated the effects on the resistor element, itself, but also upon the materials used for encapsulation, substrates, binders and lead materials. A summary of the significant points is presented below.

1. Wirewound resistors are the least affected types, followed in order by metal films, carbon films, and carbon composition resistors.
2. Epoxy resins, used as binders in carbon composition resistors become brittle and carbonized, decreasing the resistance of the unit.
3. Glasses containing boron and used for hermetically sealed encapsulations and film substrates are highly undesirable.
4. Wirewound AGS resistors are not suitable for use in radiation environments, the end seals of these resistors are made from Teflon which degrades and turns to powder for very low dosages of radiation.
5. Thinly coated film resistors change as much as 300 percent during irradiation and exhibit no recovery after removal from the radiation environment.
6. Contrary to the excellent performance of pure metal film resistors, metallic oxide units, such as tin oxide film resistors, can be expected to change value as much as 50 percent under irradiation.
7. Wirewound resistors exhibit little or no noticeable degradation under steady state nuclear radiation.
8. Molded and ceramic encapsulations are highly resistant to degradation under irradiation.

For the greatest stability with respect to radiation damage, molded and ceramic encased metal film and wirewound resistors should be used.

Capacitors. Nuclear radiation affects, to some extent, most of the electronic properties of capacitors. Changes in the capacitance value, dissipation factor, and leakage resistance have been observed during steady-state reactor experimentation. These effects are generally not considered severe for fast-neutron fluences less than 10^{15} n/cm², and for most capacitors this limit is about 10^{17} n/cm².

During a high-intensity pulse of nuclear radiation, the most pronounced effect in a capacitor is a transient change in the conductivity of the dielectric material. The properties of these transient changes in the dielectric conductivity are the subject of this section.

Experimentation has been performed to determine the relative effectiveness of neutrons and gamma radiation in producing this transient radiation effect on the conductivity. The results indicate that gamma radiation is more effective than neutrons; however, neutrons can produce significant transient effects in some capacitors.

Effects of pulsed radiation on the capacitance value have been shown to be less than 0.1 percent for frequencies of the applied signal up to about 200 kHz. Dissipation-factor measurements made prior to and after irradiation indicate no clear trend in the effect in this parameter, although changes in the range of ± 20 percent were observed. It is clear, however, that the major effect is the decrease in the effective leakage resistance of the capacitor, i.e., enhanced conductivity.

Mild to moderate damage to capacitors can be expected to result from nuclear-radiation fluences between 10^{13} and 10^{16} n cm⁻², with moderate to severe damage occurring in the range of fluence from 10^{15} to 10^{18} n cm⁻². Electrolytic capacitors will be damaged at fluences of about 10^{13} n cm⁻², while capacitors with inorganic dielectric materials such as glass, ceramic, and mica are considered to be radiation resistant up to 10^{18} n cm⁻².

Ceramic and tantalum capacitors exposed to 22-MeV-proton fluences ranging from 1.16×10^{13} to 2.31×10^{13} p cm⁻² were unaffected by the radiation.

DESIGNING RADIATION-HARDENED EQUIPMENT

The general design goal in hardening circuits and equipment is to minimize or optimize charge redistribution. How this is done depends on the type of circuitry. In linear circuits, the optimizing may affect system philosophy. It may be desirable to have a large but brief transient, rather than a small but long one, or vice versa.

The most common redistribution situation in linear circuits is for a circuit to be saturated by transients and to behave like a switching circuit, having on, off and recovery times controlled by active and passive devices and their charge distribution.

Good design can control this through intelligent selection of time constants, cutoff clipping and saturation clamping. But these techniques are sometimes difficult to apply because they usually involve low impedances.

In the collector circuits of common-emitter amplifiers, for instance, the low impedances reduce gain and increase saturation currents. The collector load may have to be clamped to some value below saturation and clipped to some point above cutoff.

If collectors are clipped and clamped just outside normal signal excursion limits both the magnitude and the time of response will be minimized. But to do this, a current-limiting resistor may have to be put into the emitter circuit, even though this may produce degeneration. The value of the limiting resistor should be low, as determined by the collector voltage limit and a safe transistor current.

Time constants of circuits intended for radiation environments should be fast to aid recovery. If low-frequency response is desired, Zener diodes sometimes can be used instead of coupling capacitors. However radiation tends to round out the knee of their usually sharp-breaking regulation curve. These diodes should feed into low-impedance bleeders in the base circuit.

Radiation can degrade linear circuits without saturating them into becoming digital, though this is less common. When a circuit continues to operate linearly in radiation, each stage can act as a noise generator for the succeeding stage. Therefore, the circuit must be designed for noise immunization. Unfortunately, the noise spectrum will be within the operating range of the circuit because this spectrum is controlled by the circuit time constants. The only real relief comes from minimizing the amplitude of the noise signal. This can be done by reducing front-end gain and increasing final-stage gain. Or it can be done by selective filtering and feedback to reduce major frequency components of the noise response while maintaining circuit bandwidth.

Guidelines

Component Selection. Transistors should be picked for their relative insensitivity to radiation. This usually means that units should have small photocurrents. Silicon is still generally preferred to germanium. Alloy construction is more desirable than grown or diffused techniques, and narrow bases are preferable to wide ones. High-frequency silicon transistors are worth considering for first stages because high power dissipation is usually not required there. Epitaxial, field-effect and thin-film active and passive devices also should be considered. Radiation-sensitive devices selected to compensate for the response of other sensitive components should be chosen carefully because manufacturing batches differ in response, and quality-control groups do not always test for radiation sensitivity.

Bias Design. Many studies show that transient output current is an increasing function of bias current and is almost independent of collector-to-emitter voltage. Therefore, first stages should be operated at levels as low as possible when they work below the peak h_{fe} vs I_c characteristic, even if this means some loss of gain.

Impedance Design. High-impedance circuits are sensitive to transient radiation because of shunt leakage and current-injection effects. An input impedance of 1 Meg at transient gamma dose rates up to 10^6 roentgens/sec is considered the maximum that can be achieved during a radiation pulse. Dose rates greater than 10^6 roentgens/sec produce even smaller transient impedance magnitudes. Circuits having an input or load impedance of 100 K ohms or more will therefore be seriously affected by dose rates at least as large as 10^6 roentgens/sec, regardless of the active component used.

Transient output current from transistors is largest when the transistor operates into a low load impedance from a large input impedance. So radiation-hardening specialists suggest the use of the largest possible load resistors consistent with the power supply available, even though low-impedance loads provide higher saturation currents. In total change in charge, $i\Delta t$, Δt is a function of drive or of the extent to which the transistor is driven into saturation. For a given radiation rate or dose in a short time, total change in charge may be larger for larger load impedances. Therefore, it is usually necessary that the load be selected on the basis of desired gain, except where peak current or integrated charge obviously should be minimized.

However, the load normally can be optimized for power or voltage gain. Time and magnitude of response to radiation are also functions of transistor base impedance, which can be minimized by design control of the base circuit impedance. Load impedance can also be reduced by clipping and clamping to limit load excursion, as described previously. This drops the collector load to a very low value after an excursion threshold is reached. The total load is then contained in the degenerative emitter circuit.

Other Hardening Techniques

Radiation-induced signals can be minimized by using a differential amplifier that has been balanced. Another technique is to take advantage of phase reversal associated with common emitter stages to achieve significant amounts of cancellation through preamplifier first stages.

In digital circuits, where threshold-exceeding current can cause failure, radiation-performance can usually be calculated if component performance is known. The basic problem is to choose transistors with small primary photocurrents to assure safety margin. Transistors that are minimally susceptible to saturation, or which recover rapidly from saturation, are desirable because switching circuits easily saturated at moderate repetition rates can be made inoperative for long periods.

Entire circuits should be potted in compounds that will not conduct when irradiated. This will prevent leakage paths caused by air ionization. Because most circuits are potted, care should be taken that no air pockets are left on or near the surfaces of components.

Photocurrent pulses produced in high-frequency transistors have a typical rise time of a few microseconds and fall times only slightly longer. Many low-frequency circuits can be designed to filter out such transients, rather than amplify them. Circuits can also be designed to respond only to relatively larger pulses with greater rise and fall times.

If many logic circuits are driven into saturation simultaneously, high-current drain may exceed the power supply available and individual transistors and diodes may be turned out.

Later stages of an amplifier or digital circuit may be saturated by large transients in earlier stages and may stay in saturation longer than the duration of the radiation pulse. Typical saturation times for 1- μ sec pulses, representing a total exposure of 10 roentgens, range from 3 to 15 μ sec. Saturation lasting milliseconds have been observed in some circuits.

It is often better for the load on the final stage of an amplifier to be small, so that transient voltages across it are small, although conflicting requirements may call for a high load impedance in the first stage.

RELIABILITY

In Table 2 a comparison is made between radiation requirements and reliability.

Table 2
RADIATION HARDENING VERSUS RELIABILITY

Parameter	Radiation Requirement	Reliability Requirement
Voltage	High doping levels limit the effect of irradiation on material resistivity. Selection of the lowest useable voltage rating allows the use of low resistivity, highly doped materials.	Derating factors above operating voltages are recommended for all components in a high reliability system. Operating a device at too low a voltage level may cause marginal propagation times.
Current	Maximum current density is recommended in the radiation environment.	Minimum current, properly derated, is recommended for high reliability systems.
Frequency	The maximum f_t available in a device has been found to correlate well with the device hardness level. Gain-bandwidth products greater than 1 GHz are recommended.	For power devices, a high f_t unit is more likely to be unreliable because it is more vulnerable to secondary breakdown.
Masking	Use of the smallest possible geometries is required to minimize device response to both neutron and transient gamma environments. Both area and volume should be minimized.	The smaller the volume and area of the device's construction, the greater the chance of a positioning or diffusion depth error. Thus reliability and yield may be reduced.
Base Width	Minimum base width reduces the area in the base which contributes to the forward biasing exhibited in the base emitter junction during transient radiation. Also, the narrow base region will aid post neutron beta, since there is less chance for electron recombination before attaining the collector region.	Base widths on the order of 0.3 microns have been constructed. The danger of punch-through in a base of this magnitude is increased. In addition, the use of thin base regions in power devices increases the threat of secondary breakdown by limiting current fanout.

Table 2 (continued)

Parameter	Radiation Requirement	Reliability Requirement
Internal base resistance	At some level of transient gamma radiation, the transient current thru the internal base resistance will develop sufficient voltage to forward bias the base-emitter junction and turn the device on. Low values of resistance will thus increase the radiation failure threshold.	The base doping, which determines the internal base resistance, also affects the doping level of the emitter and collector. In some cases, the lowest value of base resistance may not allow optimum doping for collector and emitter regions.
Bonding	Use of aluminum bonding is recommended.	Full strength of aluminum bonds may be somewhat less than that of other techniques presently used. In addition, ball bonding is not useable. Whether these effects are significant to device reliability remains to be determined.
Materials	Changes in packaging, packaging materials, and bonding may be required.	Existing materials have established reliability records.

BIBLIOGRAPHY

1. Surface Effects of Radiation on Semiconductor Devices, J. P. Mitchell and D. K. Wilson. Bell System Technical Journal, Jan. 1967, Vol. XLVI, Number 1
2. Radiation Effects Information Center Report No. 39. Jan. 31, 1956, Battelle Memorial Institute, Columbus, Ohio
3. Radiation Resistance Hybrid Circuits, D. McWilliams, W. Cooke, J. Singletary, and W. Cox. LMSC-A951979, June 1969
4. Transient Radiation Effects on Electronics Equipment Handbook. DASA 1420, Battelle Memorial Institute
5. Space Radiation Equivalence for Effects on Transistors, R. Brown and W. Horne, The Boeing Company, NASA CR-814